

**REPORT ON
SUB-SOIL INVESTIGATION WORK**

**PROJECT:
PROPOSED CONSTRUCTION OF (G+9)- STORIED
RESIDENTIAL BUILDING AT 284/9, NABINBAGH,
KHILGAON, DHAKA-1219, BANGLADESH.**

**CLIENT:
MCGRATH DEVELOPMENTS LTD.**

SEPTEMBER - 2024



DIGITAL SURVEY SOLUTION

**House-A/69 (5th Floor), Road-06, Bhumipolli,
Narayanganj, Bangladesh.**

Email: surveybd2014@gmail.com

Mobile: +8801814206968

CONTENTS

- 1 REPORT ON SUB-SOIL INVESTIGATION
 - 1.1. INTRODUCTION AND BACK GROUND
 - 1.2. PURPOSE OF THE STUDY
 - 1.3. SCOPE OF WORKS
 - 1.4. LIMITATIONS
 - 1.5. SEISMOLOGY
 - 1.6. SITE LIQUEFACTION CHARACTERISTICS
- 2 INVESTIGATION PROGRAM
 - 2.1 FIELD INVESTIGATION
 - 2.2 EXECUTION OF BORINGS
 - 2.3 STANDARD PENETRATION TESTS (SPT)
 - 2.4 DISTURBED SAMPLE COLLECTION
 - 2.5 UNDISTURBED SAMPLE COLLECTION
 - 2.6 RECORDING OF GROUND WATER TABLE
 - 2.7 OTHER FIELD TESTS
 - 2.8 LABORATORY INVESTIGATION
- 3 DETAILED CALCULATIONS
 - 3.1 DETERMINATION OF BEARING CAPACITY OF SOIL FOR FOOTING
 - 3.2 DETERMINATION OF PILE CAPACITY (SINGLE PILE)
- 4 CONCLUSION & RECOMMENDATION

APPENDIX – A: SITE PLAN & BORE LOG

APPENDIX – B: LABORATORY TEST

APPENDIX – C: BEARING CAPACITY CALCULATION

1.1. INTRODUCTION AND BACK GROUND

DIGITAL SURVEY SOLUTION were commissioned for carrying out sub soil investigation works and geotechnical features of the following project:

Client	:	McGrath Developments Ltd
Name of Project	:	Proposed Construction of (G+9)-Storied Residential Building
Site Location	:	248/9, Nabinbagh, Khilgaon, Dhaka-1219.

DIGITAL SURVEY SOLUTION located at House-A/69 (5th Floor), Road-06, Bhumipolli, Narayanganj, Bangladesh is a well-known firm & has been entrusted to engage with the geotechnical investigation work for the above-mentioned site by the concerned authority.

Technical soil data obtained from the field investigations (subsoil conditions and groundwater condition) are presented in this report along with the analyses of bearing capacity of foundations of a different range of size and depth & different laboratory test results. This report is being written to provide guidelines for foundation design.

The tests and terminologies used in this report are according to BNBC-2006, AASHTO/ASTM , ACI code and other standard codes. The site investigations generally follow accepted practices for geotechnical engineering. The format and contents are guided by the client specific needs and economics.

1.2. PURPOSE OF THE STUDY

The purpose of investigation is to determine the existing soil profiles and engineering characteristics of the subsurface conditions at the site and to provide the designer with comments on the following:

- Suitable footing types, founding depths and geotechnical design parameters which will be required for a safe and economic design and excavation of the engineering works, such as the soil bearing capacity, expected foundation settlement, side slope stability, hydrological conditions at the site and other special recommendation which depends on the nature of the site.
- Methods of construction of foundation and footings, site seismicity characters, groundwater conditions, quality control requirements and outdoor subgrade and soil retaining parameters.

1.3. SCOPE OF WORKS

The scope of investigation for this study comprises the following:-

- Collecting information such as geological and geotechnical maps related to the project site, public services, and land use maps.
- Making visits for site reconnaissance in order to collect information about site nature, topography of the site, geological features and other properties concerning the project site.
- Drilling boreholes and collecting soil samples from field at desired intervals for subsequent observation and laboratory testing.
- The soil investigation both in the field and laboratory were carried out in detail to evaluate the mechanical, physical and geotechnical properties of safe and economic foundation with a view to recommend the safe and economic foundation for the proposed structures to be constructed within the investigation site.
- The report contained the works program, methodology of the field and laboratory investigation works, discussions on physical and engineering properties of sub-soil formation encountered during investigation, evaluation of laboratory test data, analysis of bearing capacities, foundation recommendations and charts and graphs representing the field and laboratory test results.

The laboratory test results, analysis, discussion and recommendations which are presented in this report are valid only for the locations where the actual investigations have carried out.

1.4. LIMITATION

The results provided in the report are indicative of the sub-surface conditions on the site only at the specific sampling and/or testing locations, and then only to the depths investigated and at the time the work was carried out. Sub-surface conditions can change abruptly due to variable geological processes and also as a result of human influences. Such changes may occur after DSS's field testing has been completed.

DSS's advice is based upon the conditions encountered during this investigation. The accuracy of the advice provided by DSS in this report may be affected by undetected variations in ground conditions across the site between and beyond the sampling and/or testing locations. The advice may also be limited by budget constraints imposed by others or by site accessibility.

This report, or sections from this report, should not be used as part of a specification for a project, without review and agreement by DSS. This is because this report has been written as advice and opinion rather than instructions for construction.

1.5. SEISMOLOGY

Bangladesh has been divided into three seismic zones with different levels of ground motion. A map of Bangladesh showing the boundaries of the three zones is provided in Appendix B. It indicates the seismic zoning map of Bangladesh. Each zone has a seismic zone coefficient (Z) which represents the maximum considered Peak Ground Acceleration (PGA) on very stiff soil/rock. The zone coefficients of the three zones are:

Z = 0.12 (Zone 1)

Z = 0.20 (Zone 2)

Z = 0.28 (Zone 3)

Z = 0.36 (Zone 4)



Fig No 1.1: Seismic Zoning Map of Bangladesh (As per BNBC 2022)

1.6 SITE LIQUEFACTION CHARACTERISTICS

Liquefaction is defined as the transformation of a granular materials from a soil to a liquefied state as a consequence of increased pore-water pressure and reduced effective stress (Marcuson, 1978). Increased pore pressure may be induced by the tendency of granular materials to compact when subjected to cyclic shear deformation, such as in the event of an earthquake. As per IS: 1893 (Part 1)-2016, liquefaction is likely in loose fine sand (SP) below the water table.

Many methods to predict liquefaction have been proposed and put to practical use in the design of structures. Some examples of predicting liquefaction adopted in the Japanese standards are indicated as follows:

- i. Liquefaction Resistance Factor (F_L) Method
 - a. Architectural Institute of Japan (1988)
 - b. Japan Road Association (1996)
- ii. Liquefaction Potential Index (P_L) Method
 - a. Iwasaki et al. (1980)
 - b. Tokyo Metropolitan Disaster Conference Method (1991)

As an index for the assessment of liquefaction potential, the liquefaction potential index (P_L value) is adopted in earthquake damage assessment of many local governments in Japan. Alternately, the liquefaction safety factor (F_L) is calculated for every layer derived from drilling data, geology sections, and conditions of the geomorphological unit. The possibility of liquefaction can be presented by liquefaction safety factor (F_L) and liquefaction potential index (P_L) which are generally connected as follows.

$F_L > 1.0$ --There is little possibility of liquefaction

$F_L \leq 1.0$ --There is the possibility of liquefaction

$P_L = 0$ --Liquefaction potential is quite low

$0 < P_L \leq 5$ --Liquefaction potential is low.

$0 < P_L \leq 15$ --Liquefaction potential is high.

$P_L > 15$ --Liquefaction potential is very high,

The ratio F_L has been designated variously as liquefaction susceptibility, factor of safety against liquefaction, and liquefaction resistance factor.

2. INVESTIGATION PROGRAM

To appraise the required geotechnical parameters for foundation design of the proposed structure, the investigation program has been set into the following steps:

- i) Field Investigation works and
- ii) Laboratory Tests.

2.1 FIELD INVESTIGATION WORKS

The actual field investigation work was started on 10/09/2024 and was completed on 16/09/2024.

Number of Boring	:	07	Depth of Boring	:	31.5 m (max)
SPT Execution	:	143	Interval of SPT execution	:	1.5 m
Disturbed sample	:	143	Undisturbed Sample	:	Nil
Compaction Test	:	Nil	Water Table Level below	:	1.5 m
Permeability Tests	:	N/A	Other Tests	:	N/A

2.2 Execution of Borings

The boring was conducted using 100 mm diameter casing. The method consists in first driving a casing through which a hollow drill rod with a sharp chisel or chopping bit at the lower end is inserted. Water is forced under pressure through the drill rod which is alternatively raised and dropped, and also rotated. The soil cuttings are forced upto the dropped and also rotated. The soil cuttings are forced upto the ground in the drilled rod and casing. Before taking SPT and collection of disturbed and undisturbed soil samples, the bore hole is cleaned with repeated circulation of mud slurry.

2.3 Standard Penetration Tests (SPT)

The standard Penetration Tests (SPT) was performed in all the bore holes locations. Standard Penetration Test was conducted in the boreholes at intervals of 1.5 m to 3.0 m depth or at change of strata whichever is earlier using a splits poon sampler. The split spoon sampler used is of a standard design having an outer diameter 50.8 mm and inner diameter of 35 mm.

In SPT testing, the rope-and-pulley (R-P) method would be used. This consisted of a hollow cylindrical mass sliding over a steel rod. It is operated by lifting the mass with a rope over a cat head. The tests were executed by using 63.5 kg hammer falling freely from a constant height of 760 mm. a record of the number of blows required to penetrate every 15 cms to a maximum depth of 45 cms was made. The first 15 cm of drive are considered to be seating drive and are neglected. The SPT value (N-value) was taken as the summation of blows required in 2nd and 3rd 15 cm of penetration of sampler.

On completion of a test the split spoon sampler was opened and soil specimens were preserved in polythene bags for logging purpose. The SPT values (N-values) are shown on the borehole logs against the respective interval of tests.

- The Standard Penetration Tests provide a fair knowledge on the density and consistency of the soil layer encountered and in addition yields disturbed/ semi-disturbed soil samples from within the split spoon sampler used during the tests.

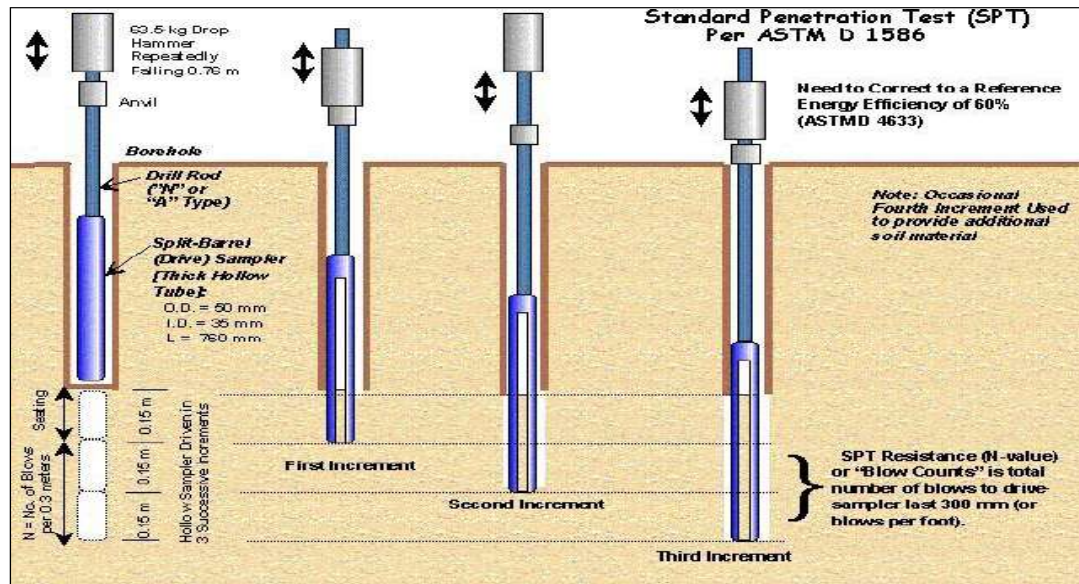

Figure for Standard Penetration Tests

2.4 Disturbed Sample Collection

The disturbed samples were collected with the help of split spoon sampler used during Standard Penetration Tests. The collected samples were classified in-situ and were preserved in water tight polythene bags with proper identification marks for onward transmission to the laboratory for further analysis.

The disturbed samples were also used to reconstruct depth wise stratification of bore holes depending on its classifications.

2.5 Undisturbed Sample Collection

The undisturbed samples were collected whenever feasible from the cohesive layers with the help of thin walled Shelby tubes 76 mm diameter thin walled Shelby tubes are penetrated into the undisturbed soil formation at the bottom of the borehole by applying rapid but continuous force. The samples recovered within the Shelby tubes were wax sealed at both ends and transmitted to the laboratory with proper identification marks.

2.6 Recording of Ground Water Table

Groundwater is one element that affects in the stability and foundation analyses. Groundwater affects many elements of the foundation design and construction, so that the ground water level was generally assessed from borehole during drilling. The ground water table was recorded in each of the boreholes by rope/rod sounding after 24 hours of completion of the drilling and sampling operation.

2.7 Other Field Tests

Any other field tests if necessary, which were conducted at site was done as per AASHTO / ASTM standard specifications.

2.8 LABORATORY INVESTIGATION

After classification and carrying out the geological description on the obtained samples, a laboratory tests program was issued; this program contained the required tests on selected samples in order to determine the physical and mechanical properties of the ground materials.

Grain Size Distribution	:	12	Atterberg Limits Test	:	07
Specific Gravity	:	Nil	Moisture Content	:	07
Unconfined Compression Test	:	04	Consolidation Test	:	Nil
Direct Shear Test	:	12	Standard Proctor Test	:	Nil
Free Swell Index	:	Nil	Chemical Test	:	Nil

Where applicable, the tests were performed according to American Society for Testing and Materials (ASTM) Standard as follow:

Table No.3: Common Soil Laboratory Tests Used in Geotechnical Engineering

Type of condition	Soil Properties	Specification
Index Test	Classification	ASTM D 2487-93
	Particle size	ASTM D 422-90
	Atterberg limits	ASTM D 4318-95
	Water (or moisture) content	ASTM D 2216-92
	Specific gravity	ASTM D 854-92
	Index Tests Sand equivalent (SE)	ASTM D 2419-95
Settlement	Consolidation	ASTM D 2435-96
	Organic content	ASTM D 2974-95
	Fill compaction: Standard Proctor	ASTM D 698-91
	Fill compaction: Modified Proctor	ASTM D 1557-91
Shear strength for slope movement	Unconfined compressive strength	ASTM D 2166-91
	Unconsolidated undrained	ASTM D 2850-95
	Consolidated undrained.	ASTM D 4767-95
	Direct shear	ASTM D 3080-90

- Other tests will be defined depending on the clients and engineers requirement if applicable.
- The soils will be also classified based on the Unified Soil Classification System (USCS).

3.1 DETERMINATION OF BEARING CAPACITY OF SOIL FOR FOOTING

The SPT is widely used to obtain the allowable bearing capacity values in the following general equation for sandy soil (for Maximum 25 mm settlement)

A. Cohesive soil:

$$Q_u = 5.14 * C_u * (1 + 0.2 * D_f / B) * (1 + 0.2 * B / L) * B * L ; [Skempton (1951)]$$

B. Cohesionless soil:

i) for $B \leq 4.0\text{ft}$

$$Q_u = (N_{\text{corr}} / 2.5) * (F_d * S) * B * L ; [Bowles (1977)]$$

ii) for $B > 4.0\text{ft}$

$$Q_u = (N_{\text{corr}} / 4.0) * (F_d * S) * ((B+1)/B)^2 * B * L ; [Bowles (1977)]$$

where,

Q_u = Net Ultimate Bearing Capacity (kip)

C_u = Undrained Cohesion (ksf)

N_{corr} = Corrected SPT for overburden pressure

B = Width of foundation (ft)

L = Length of foundation (ft)

F_d = Depth factor = $1 + 0.33 * (D_f / B) \leq 1.33$

D_f = Depth of foundation from EGL (ft)

S = Tolerable Settlement (inch)

❖ Terzaghi Ultimate Bearing Capacity Theory

$$Q_u = c N_c + \gamma D N_q + 0.5 \gamma B N_\gamma$$

= Ultimate bearing capacity equation for shallow strip footings, (kN/m²) (lb/ft²)

$$Q_u = 1.3 c N_c + \gamma D N_q + 0.4 \gamma B N_\gamma$$

= Ultimate bearing capacity equation for shallow square footings, (kN/m²) (lb/ft²)

$$Q_u = 1.3 c N_c + \gamma D N_q + 0.3 \gamma B N_\gamma$$

= Ultimate bearing capacity equation for shallow circular footings, (kN/m²) (lb/ft²)

❖ Mayerhof's Equation (1963) for Bearing Capacity

$$Q_a = Q_u / F.S. = (c.N_c.s_c.d_c.i_c + 0.5.\gamma_1.B.N_r.s_r.d_r.i_r + \gamma_2.D_f.N_q.s_q.d_q.i_q) / F.S.$$

❖ Hensen's Equation (1970) for Bearing Capacity

$$Q_a = Q_u / F.S. = (c.N_c.s_c.d_c.i_c.g_c.b_c + 0.5.\gamma_1.B.N_r.s_r.d_r.i_r.g_r.b_r + \gamma_2.D_f.N_q.s_q.d_q.i_q.g_q.b_q) / F.S.$$

where

$$N_c = \cot\phi(N_q - 1),$$

$$N_q = e^2(3\pi/4 - \phi/2)\tan\phi / [2\cos^2(45 + \phi/2)],$$

k_p = Passive pressure coefficient

$${}^2N_\gamma = (1/2) \tan\phi(k_p / \cos\phi - 1),$$

e = Napier's constant = 2.718...,

s_c, s_r, s_q = Shape Factors

d_c, d_r, d_q = Depth Factors

i_c, i_r, i_q = inclination Factors

Allowable net bearing capacity, $Q_{\text{all}} = Q_u / (F.S.=3.0)$

3.2 DETERMINATION OF PILE CAPACITY (A SINGLE PILE)

The load applied to a single pile is carried jointly by the soil beneath the tip of the pile (End Bearing) and by soil around the shaft (Skin Friction), with deducting the self-weight of the pile and the maximum load that the pile can support. The pile capacity is given by-

$$Q_{ult} = \text{Base Resistance, } Q_p + \text{Shaft Resistance, } Q_s - \text{Weight of pile} \\ = A_p * E_b + f_s * \pi * D * L - W_p$$

Where,

E_b = end bearing capacity

D = diameter of pile

f_s = shaft resistance (skin friction)

L = length of pile

A_p = area of pile point

Design load capacity, $Q_a = Q_{ult} / F.S.$

where, F.S. , Factor of Safety = 2.5 for all cohesive and cohesionless soil

1. Ultimate Skin Friction

Cohesive soil: $Q_s = \alpha * C_u * A_s$; [Tomlinson Formula (α method)]

where,

Q_s = ultimate skin friction of pile (kip)

α = empirical adhesion factor or friction constant

C_u = undrained cohesion [= N/8 (ksf), where no data is available]

A_s = circumferential area of pile (sft)

Cohesionless soil: $Q_s = 0.02 * N_{corr} * A_s$; [Meyerhof (1976)]

where,

Q_s = ultimate skin friction of pile (kip)

N_{corr} = corrected SPT for overburden pressure

A_s = circumferential area of pile (sft)

2. Ultimate End Bearing Capacity

Cohesive soil: $Q_p = 9 * C_u * A_p$; [Skempton's Formula]

where,

Q_p = ultimate end bearing capacity of pile (kip)

C_u = undrained cohesion [=N/8 (ksf), where no data is available]

A_p = tip area of pile (sft)

Cohesionless soil: $Q_p = 2.66 * N_{corr} * A_p$; [Meyerhof (1976)]

where,

Q_p = ultimate end bearing capacity of pile (kip)

N_{corr} = corrected SPT for overburden pressure

A_p = tip area of pile (sft)

4. CONCLUSION & RECOMMENDATIONS

The Recommendations submitted in this report are prepared on the basis of obtained field SPT & available subsurface Samples from field and subsequent laboratory tests for the exclusive use of the project mentioned below:

Client	:	McGrath Developments Ltd
Name of Project	:	Proposed Construction of (G+9)-Storied Residential Building
Site Location	:	248/9, Nabinbagh, Khilgaon, Dhaka-1219.

- The sub-soil formation encountered at the proposed site is almost homogeneous and the degree of disintegration varies slightly at places. The sequence of litho logical composition as well as consistency of the soil at different depths has been depicted in the respective bore logs **BH-1** Through to **BH-07** in Appendix A.
- RCC Cast-in-situ piles may be installed below the foundation. **Determining effective length of a pile segment requires engineering judgment.** The Allowable Load Bearing Capacity (Ton) of **20-inch Dia** RCC Cast-in-situ pile for different depth is given below.

Pile Size, inch	Depth From EGL, (ft)	Allowable Load Bearing Capacity (Ton) Considering Factor of Safety = 2.5						
		BH-01	BH-02	BH-03	BH-04	BH-05	BH-06	BH-07
20" Cast-in situ	70	95.71	101.45	76.68	83.85	88.36	70.61	78.97
	75	104.88	110.61	88.30	92.03	99.49	78.30	90.10
	80	117.84	123.64	99.92	102.67	113.18	91.39	106.05

- Soil parameters for foundation design as well as the allowable bearing capacity of soil for shallow and deep foundation are provided in the appendices.
 - **Table 1 to 1.1 for shallow foundation design.**
 - **Table 2.1 to Table 3.7 for RCC cast-in-situ pile capacity for different depth & dimensions.**
 - Linear Interpolation is acceptable for intermediate values of these capacities.
 - Laboratories tests are enclosed in Appendix B.
- **Bearing Capacity should be confirmed by plate Load Test for shallow foundation or Pile Load Test for Deep Foundation.**
- Moreover considering the magnitude of the structure, column spacing & environmental condition and location of the proposed site, the foundation engineer will put his judgment and experience to select the suitable alternative type & depth of foundation.

The material contained in this report reflects our best judgment in the light of the information available through site visit, field investigation, laboratory test and subsequent calculations.

Recommended by

(Engr. Md. Sajib Hossain)
 M.Sc. in Structural Engg.
 Yangtze University (China)
 B.Sc. in Civil Engg. (SUB)
 MIEB-42083

APPENDIX: A

SITE PLAN

&

BORING LOGS

DIGITAL SURVEY SOLUTION

CLIENT : McGrath Developments Ltd
PROJECT : Proposed Construction of (G+9)-Storied Residential Building
LOCATION : 248/9, Nabinbagh, Khilgaon, Dhaka-1219.

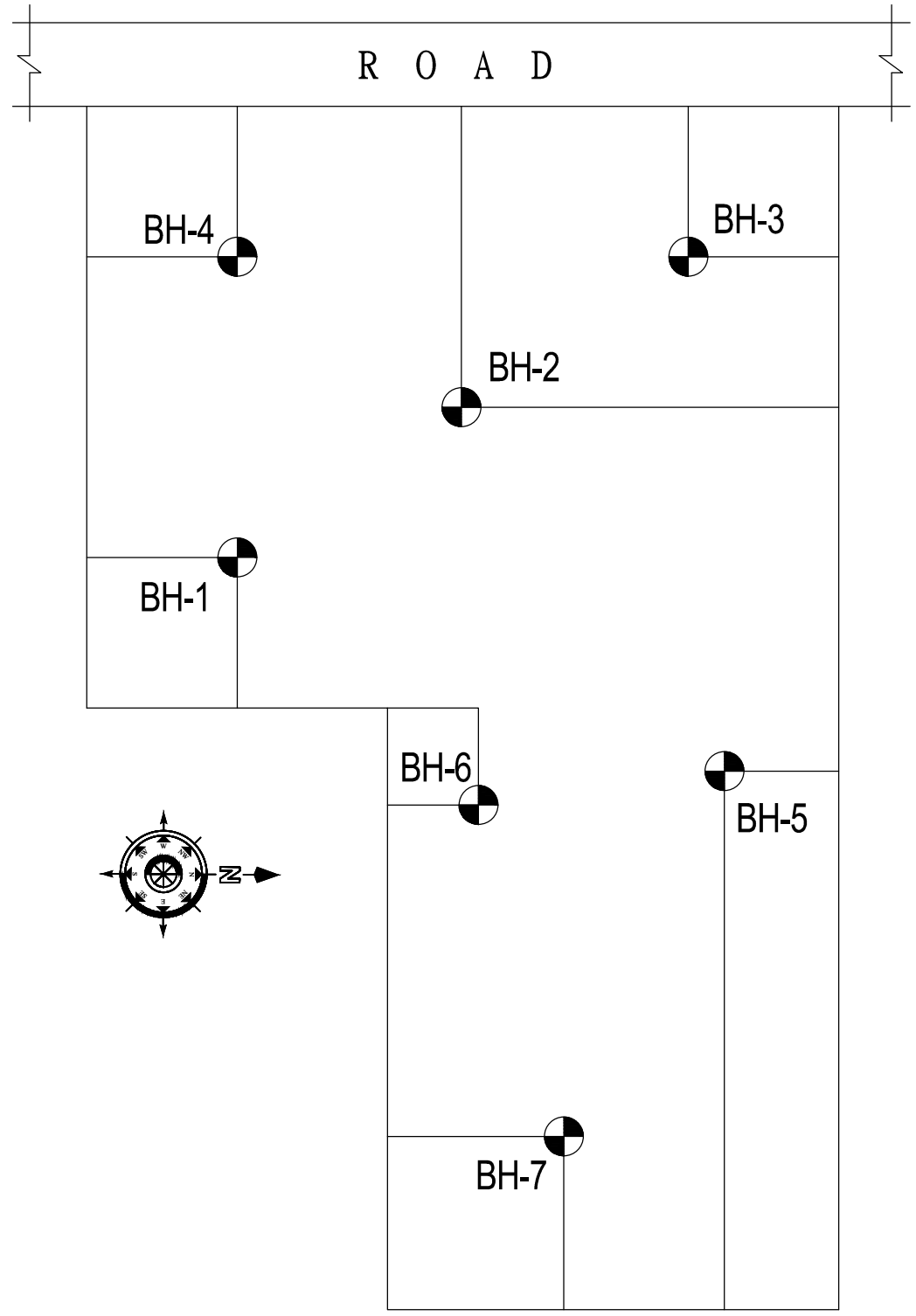

Drawn by: Abdul Awal

SITE PLAN

Not to Scale

Date:

Figure. 01

BOREHOLE LOG



DIGITAL SURVEY SOLUTION

CLIENT : McGrath Developments Ltd
PROJECT : Proposed Construction of (G+9)-Storied Residential Building
LOCATION : 248/9, Nabinbagh, Khilgaon, Dhaka-1219.

BORE HOLE # 01

Start Date : 10-Sep-2024 **R. L.** : (+) 0.00 m From Road level. **Drilling Method**: Wash Boring Method
Finish Date : 10-Sep-2024 **W. L.** : (-) 1.50 m From EGL of borehole. **Depth of Bore Hole**: 31.5 m From EGL.

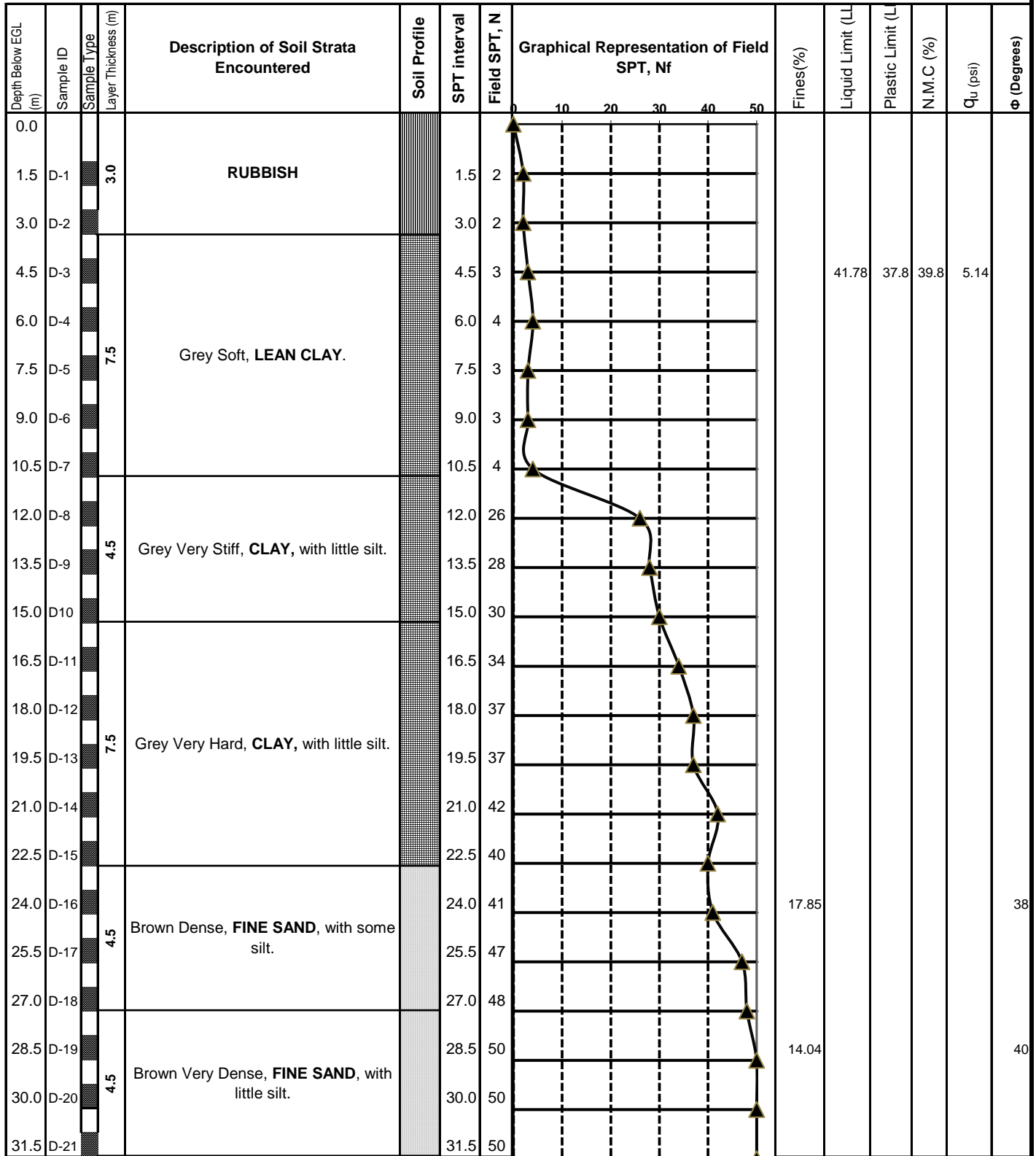

Legend:

- Disturbed Sample (D)
- Non Cohesive sand
- Cohesive Silt
- Non Cohesive filling
- Undisturbed Sample (UD)
- Cohesive soil
- rubbish

Figure : BH 01

BOREHOLE LOG



DIGITAL SURVEY SOLUTION

CLIENT : McGrath Developments Ltd
 PROJECT : Proposed Construction of (G+9)-Storied Residential Building
 LOCATION : 248/9, Nabinbagh, Khilgaon, Dhaka-1219.

BORE HOLE # 02

Start Date : 11-Sep-2024 R. L. : (+) 0.00 m From Road level. Drilling Method: Wash Boring Method
 Finish Date : 11-Sep-2024 W. L. : (-) 1.50 m From EGL of borehole. Depth of Bore Hole: 31.5 m From EGL.

Depth Below EGL (m)	Sample ID	Sample Type Layer Thickness (m)	Description of Soil Strata Encountered	Soil Profile	SPT interval	Field SPT, N	Graphical Representation of Field SPT, Nf					Fines(%)	Liquid Limit (LL)	Plastic Limit (L)	N.M.C (%)	Cu (psi)	φ (Degrees)
							10	20	30	40	50						
0.0																	
1.5	D-1	3.0	RUBBISH		1.5	1											
3.0	D-2				3.0	2											
4.5	D-3				4.5	2											
6.0	D-4	7.5	Grey Soft to Medium Stiff, LEAN CLAY .		6.0	4						36.71	30.6	35.3	6.88		
7.5	D-5			7.5	5												
9.0	D-6			9.0	6												
10.5	D-7				10.5	5											
12.0	D-8	4.5	Grey Very Hard, CLAY , with little silt.		12.0	34											
13.5	D-9			13.5	32												
15.0	D-10			15.0	37												
16.5	D-11	7.5	Grey Very Stiff to Very Hard, CLAY , with little silt.		16.5	30											
18.0	D-12			18.0	40												
19.5	D-13			19.5	42												
21.0	D-14				21.0	43											
22.5	D-15				22.5	41											
24.0	D-16	4.5	Brown Dense, FINE SAND , with some silt.		24.0	42											
25.5	D-17			25.5	47						15.94						40
27.0	D-18			27.0	50												
28.5	D-19	4.5	Brown Very Dense, FINE SAND , with little silt.		28.5	50											
30.0	D-20			30.0	50						14.03						40
31.5	D-21			31.5	50												

End of Borehole

Legend:

- Disturbed Sample (D)
- Non Cohesive sand
- Cohesive Silt
- Non Cohesive filling
- Undisturbed Sample (UD)
- Cohesive soil
- rubbish

Figure : BH 02

BOREHOLE LOG



DIGITAL SURVEY SOLUTION

CLIENT : McGrath Developments Ltd
 PROJECT : Proposed Construction of (G+9)-Storied Residential Building
 LOCATION : 248/9, Nabinbagh, Khilgaon, Dhaka-1219.

BORE HOLE # 03

Start Date : 12-Sep-2024 R. L. : (+) 0.00 m From Road level. Drilling Method: Wash Boring Method
 Finish Date : 12-Sep-2024 W. L. : (-) 1.50 m From EGL of borehole. Depth of Bore Hole: 30.0 m From EGL.

Depth Below EGL (m)	Sample ID	Sample Type Layer Thickness (m)	Description of Soil Strata Encountered	Soil Profile	Graphical Representation of Field SPT, Nf					Fines(%)	Liquid Limit (LL)	Plastic Limit (Ll)	N.M.C (%)	Cu (psi)	φ (Degrees)
					SPT interval	Field SPT, N	0	10	20						
0.0															
1.5	D-1	##	RUBBISH		1.5	3									
3.0	D-2				3.0	2									
4.5	D-3	4.5	Greyish brown Soft, CLAY , with little silt.		4.5	2									
6.0	D-4				6.0	3									
7.5	D-5				7.5	4				37.49	30.8	36			
9.0	D-6				9.0	12									
10.5	D-7				10.5	14									
12.0	D-8	7.5	Brown Stiff, CLAY , with litte silt.		12.0	13									
13.5	D-9				13.5	15									
15.0	D10				15.0	15									
16.5	D-11	4.5	Brown Very Stiff, CLAY , with litte silt.		16.5	20									
18.0	D-12				18.0	25									
19.5	D-13				19.5	30									
21.0	D-14	4.5	Brown Very Hard, CLAY , with litte silt.		21.0	37									
22.5	D-15				22.5	40									
24.0	D-16				24.0	43									
25.5	D-17				25.5	46				22.10					39
27.0	D-18	6.0	Brown Dense to Very Dense, FINE SAND , with some silt.		27.0	50									
28.5	D-19				28.5	50									
30.0	D-20				30.0	50									

End of Borehole

Legend:

- Disturbed Sample (D)
- Undisturbed Sample (UD)
- Non Cohesive sand
- Cohesive soil
- Cohesive Silt
- rubbish
- Non Cohesive filling

Figure : BH 03

BOREHOLE LOG



DIGITAL SURVEY SOLUTION

CLIENT : McGrath Developments Ltd
 PROJECT : Proposed Construction of (G+9)-Storied Residential Building
 LOCATION : 248/9, Nabinbagh, Khilgaon, Dhaka-1219.

BORE HOLE # 04

Start Date : 13-Sep-2024 R. L. : (+) 0.00 m From Road level. Drilling Method: Wash Boring Method
 Finish Date : 13-Sep-2024 W. L. : (-) 1.50 m From EGL of borehole. Depth of Bore Hole: 30.0 m From EGL.

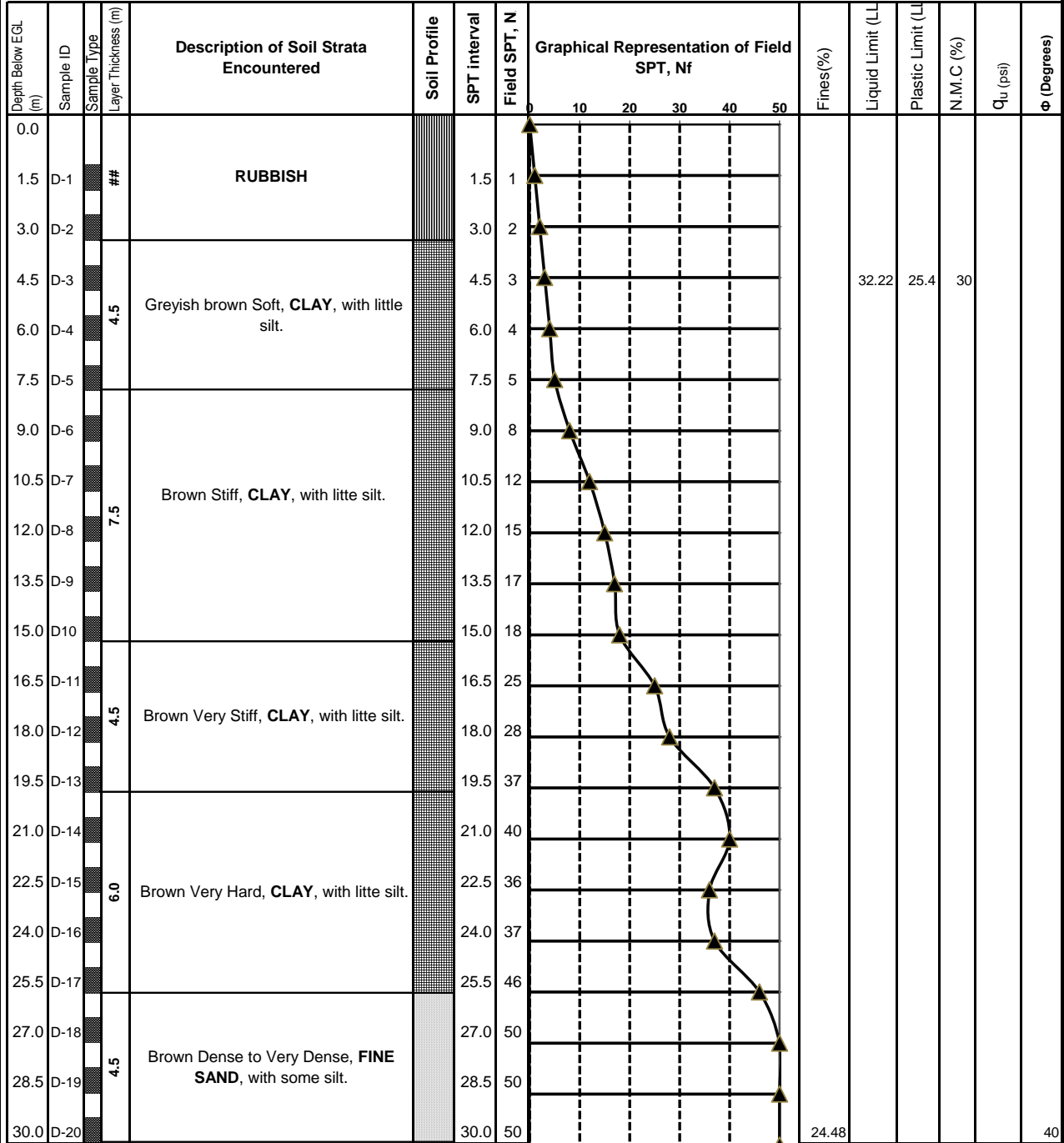

End of Borehole

Legend:

- Disturbed Sample (D)
- Undisturbed Sample (UD)
- Non Cohesive sand
- Cohesive soil
- Cohesive Silt
- rubbish
- Non Cohesive filling

Figure : BH 04

BOREHOLE LOG



**DIGITAL
SURVEY
SOLUTION**

CLIENT : McGrath Developments Ltd
PROJECT : Proposed Construction of (G+9)-Storied Residential Building
LOCATION : 248/9, Nabinbagh, Khilgaon, Dhaka-1219.

BORE HOLE # 05

Start Date : 14-Sep-2024 **R. L.** : (+) 0.00 m From Road level. **Drilling Method**: Wash Boring Method
Finish Date : 14-Sep-2024 **W. L.** : (-) 1.50 m From EGL of borehole. **Depth of Bore Hole**: 30.0 m From EGL.

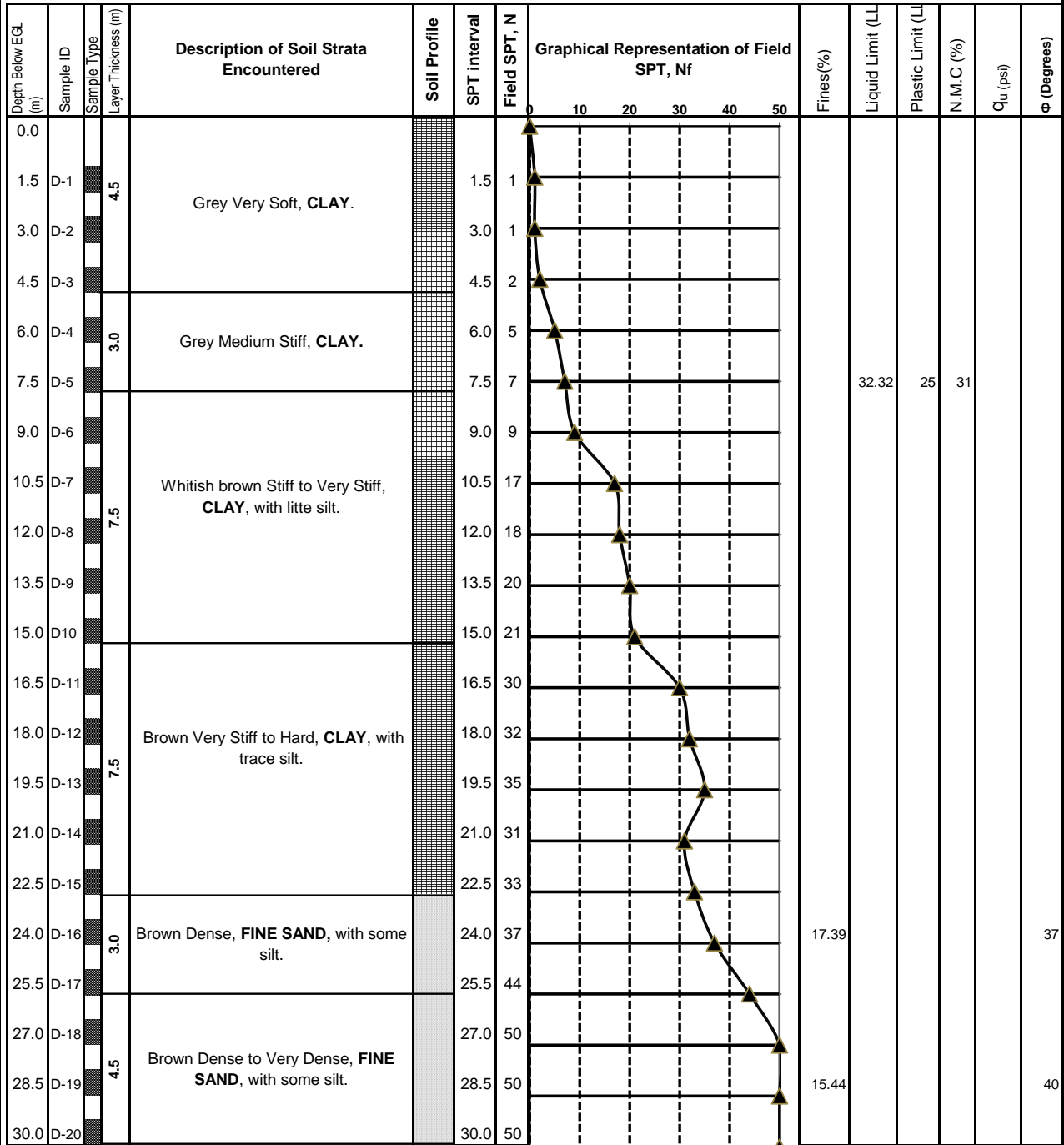

End of Borehole

Legend:

- | | | | |
|-------------------------|-------------------|---------------|----------------------|
| Disturbed Sample (D) | Non Cohesive sand | Cohesive Silt | Non Cohesive filling |
| Undisturbed Sample (UD) | Cohesive soil | rubbish | |

Figure : BH 05

BOREHOLE LOG



DIGITAL SURVEY SOLUTION

CLIENT : McGrath Developments Ltd
PROJECT : Proposed Construction of (G+9)-Storied Residential Building
LOCATION : 248/9, Nabinbagh, Khilgaon, Dhaka-1219.

BORE HOLE # 06

Start Date : 11-Sep-2024 **R. L. :** (+) 0.00 m From Road level. **Drilling Method:** Wash Boring Method
Finish Date : 11-Sep-2024 **W. L. :** (-) 1.50 m From EGL of borehole. **Depth of Bore Hole:** 31.5 m From EGL.

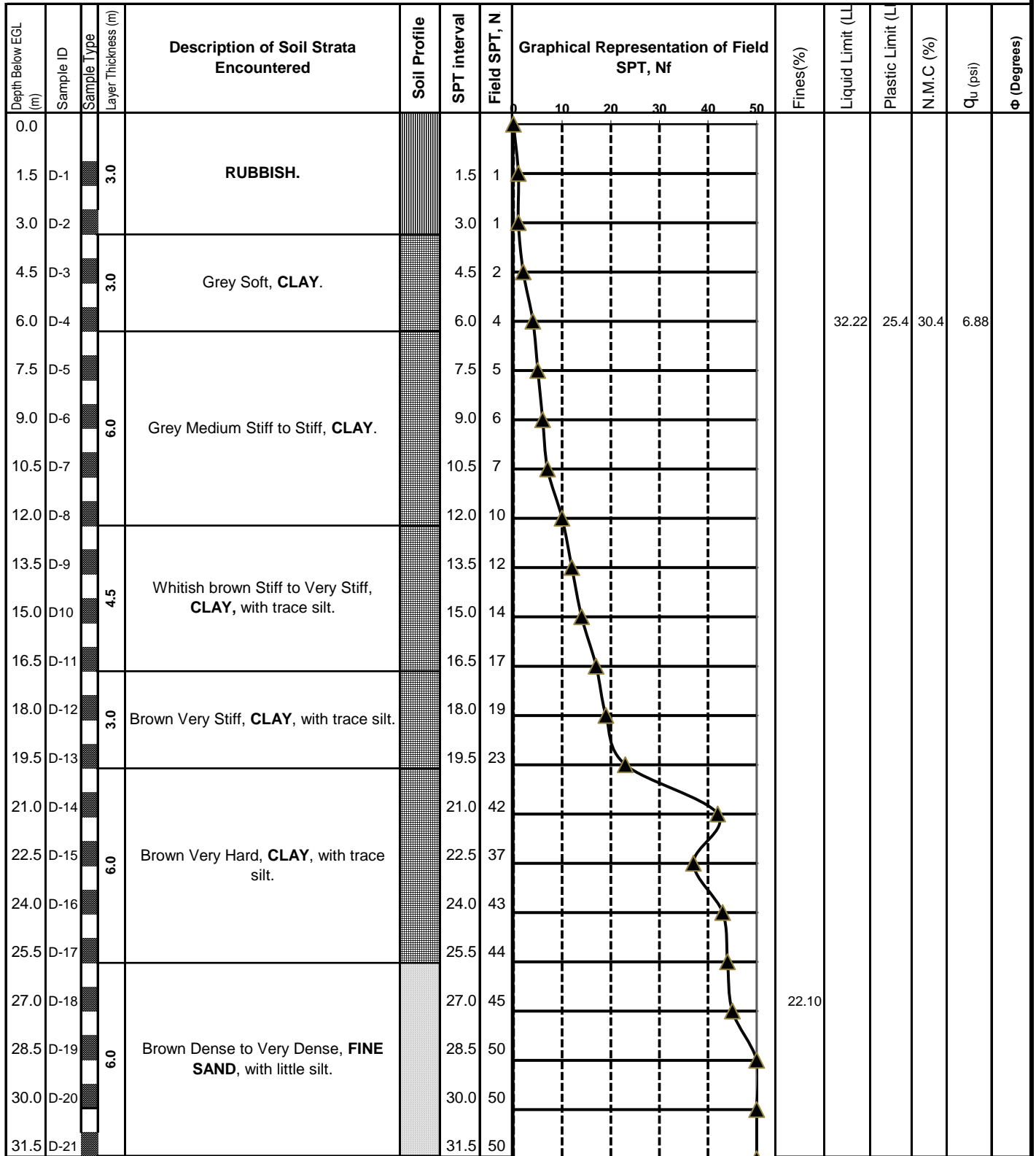

End of Borehole

Legend:

- Disturbed Sample (D)
- Non Cohesive sand
- Cohesive Silt
- Non Cohesive filling
- Undisturbed Sample (UD)
- Cohesive soil
- rubbish

Figure : BH 06

BOREHOLE LOG



DIGITAL SURVEY SOLUTION

CLIENT : McGrath Developments Ltd
 PROJECT : Proposed Construction of (G+9)-Storied Residential Building
 LOCATION : 248/9, Nabinbagh, Khilgaon, Dhaka-1219.

BORE HOLE # 07

Start Date : 16-Sep-2024 R. L. : (+) 0.00 m From Road level. Drilling Method: Wash Boring Method
 Finish Date : 16-Sep-2024 W. L. : (-) 1.50 m From EGL of borehole. Depth of Bore Hole: 30.0 m From EGL.

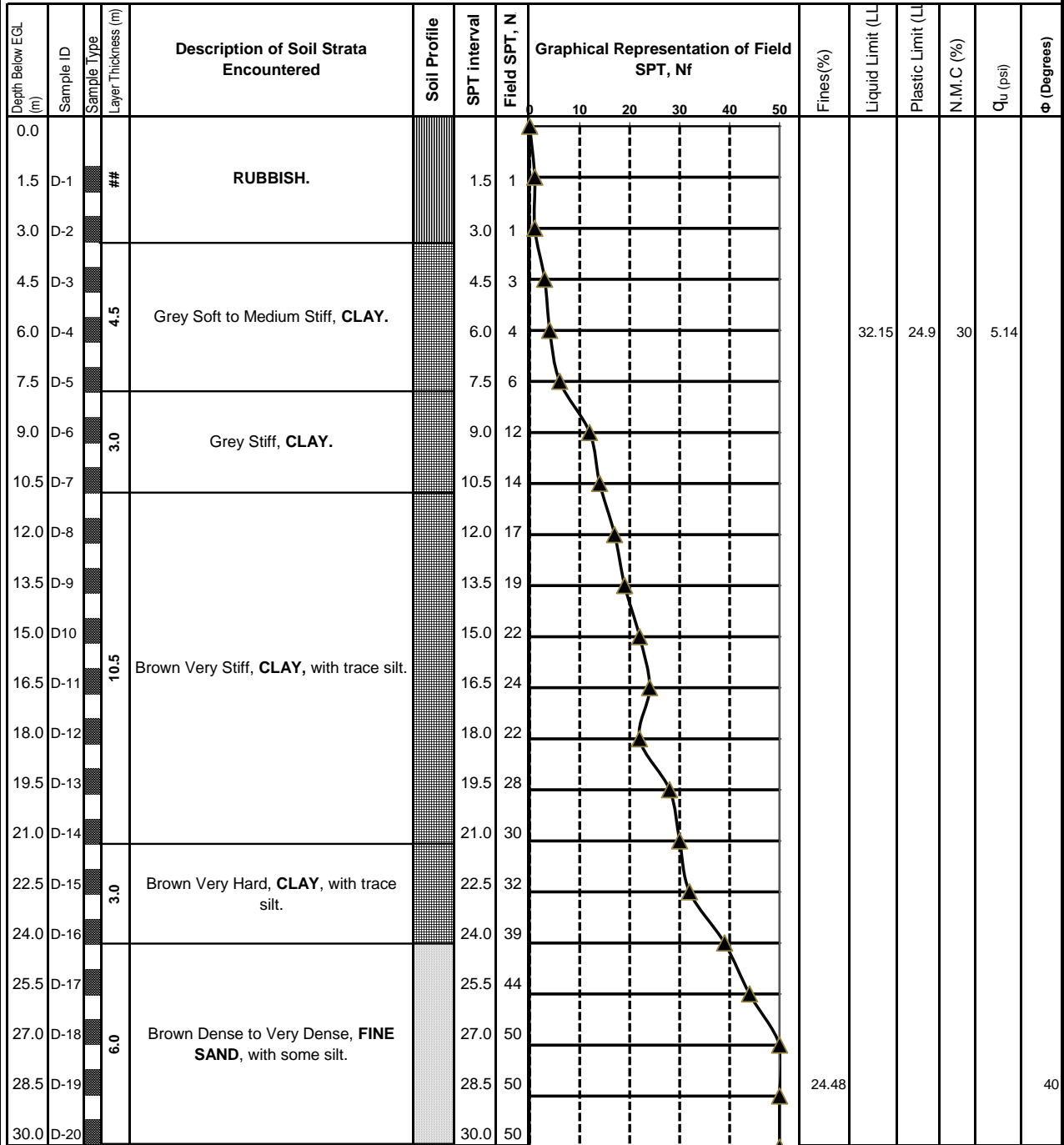

End of Borehole

Legend:

- Disturbed Sample (D)
- Undisturbed Sample (UD)
- Non Cohesive sand
- Cohesive soil
- Cohesive Silt
- Non Cohesive filling
- rubbish

Figure : BH 07

APPENDIX: B

LABORATORY TEST RESULTS

Grain Size Analysis Report (Mechanical Sieve)

As Per ASTM D422-63 (2007)

Client : McGrath Developments Ltd
Project : Proposed Construction of (G+9)-Storied Residential Building
Location : 248/9, Nabinbagh, Khilgaon, Dhaka-1219.
Boring No.: BH- 01
Sample ID: D- 16



Boring No.: BH- 01
Sample ID: D- 19

Sieve Number	Diameter (mm)	Mass of Sieve (gm)	Mass of Sieve & Soil (gm)	Soil Retained (gm)	Soil Retained (%)	Soil Passing (%)
#4	4.750	398.59	398.59	0.00	-	100.00
#8	2.360	375.15	375.15	0.00	-	100.00
#16	1.180	367.89	367.89	0.00	-	100.00
#30	0.600	342.91	344.59	1.68	2.39	97.61
#50	0.300	325.43	328.21	2.78	3.95	93.66
#100	0.150	334.98	346.61	11.63	16.54	77.11
#200	0.075	326.81	368.47	41.66	59.26	17.85
Pan		285.03	297.58	12.55	17.85	

Sieve Number	Diameter (mm)	Mass of Sieve (gm)	Mass of Sieve & Soil (gm)	Soil Retained (gm)	Soil Retained (%)	Soil Passing (%)
#4	4.750	398.59	398.59	0.00	-	100.00
#8	2.360	375.15	375.15	0.00	-	100.00
#16	1.180	367.89	367.89	0.00	-	100.00
#30	0.600	342.91	343.56	0.65	0.77	99.23
#50	0.300	325.43	331.74	6.31	7.48	91.75
#100	0.150	334.98	360.91	25.93	30.74	61.00
#200	0.075	326.81	366.42	39.61	46.96	14.04
Pan		285.03	296.87	11.84	14.04	

USCS Soil Classification: SP-SM - Poorly Graded Sand with Silt

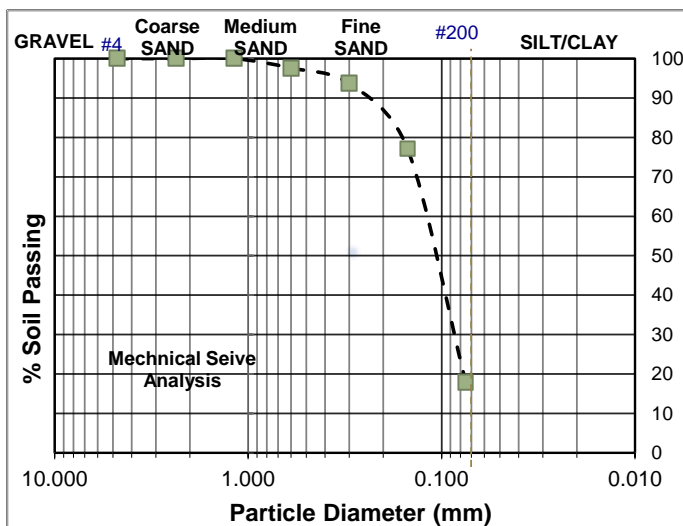

USCS Soil Classification: SP-SM - Poorly Graded Sand with Silt

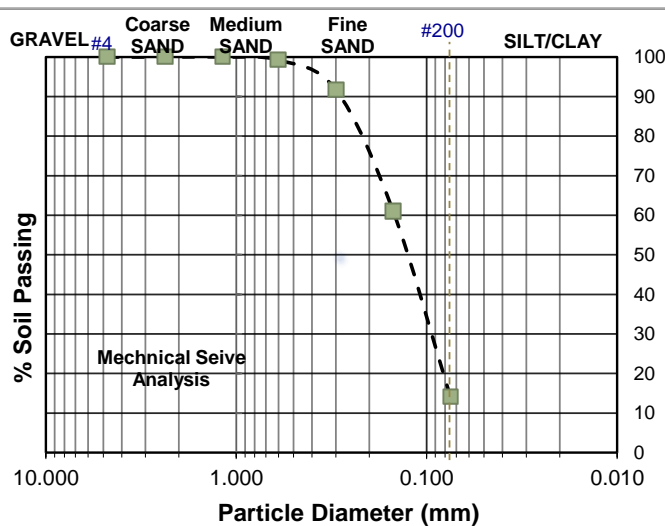

Grain Size Distribution Curve Results :

% Gravel :	0.00	C_u :		D₁₀ :	
% Sand :	82.15	C_c :		D₃₀ :	0.090 mm
% Fines :	17.85			D₆₀ :	0.128 mm
Silt Factor , f :	0.60			D₅₀ :	0.116 mm

% Gravel :	0.0	C_u :		D₁₀ :	
% Sand :	86.0	C_c :		D₃₀ :	0.100 mm
% Fines :	14.0			D₆₀ :	0.148 mm
Silt Factor , f :	0.64			D₅₀ :	0.132 mm

Test Performed by: **Abdul Awal**
Lab Technician

Countersigned by: **Engr. Md. Sajib Hossain**
B.Sc. in Civil Engg.(SUB)
M.Sc.Structural Engg.(YU,China)

Figure- GSD 01

Grain Size Analysis Report (Mechanical Sieve)

As Per ASTM D422-63 (2007)

Client : McGrath Developments Ltd
Project : Proposed Construction of (G+9)-Storied Residential Building
Location : 248/9, Nabinbagh, Khilgaon, Dhaka-1219.
Boring No : BH- 02
Sample ID: D- 17



Boring No : BH- 02
Sample ID: D- 20

Sieve Number	Diameter (mm)	Mass of Sieve (gm)	Mass of Sieve & Soil (gm)	Soil Retained (gm)	Soil Retained (%)	Soil Passing (%)
#4	4.750	398.59	398.59	0.00	-	100.00
#8	2.360	375.15	375.15	0.00	-	100.00
#16	1.180	367.89	367.89	0.00	-	100.00
#30	0.600	342.91	344.62	1.71	2.32	97.68
#50	0.300	325.43	328.19	2.76	3.74	93.94
#100	0.150	334.98	346.72	11.74	15.92	78.01
#200	0.075	326.81	372.58	45.77	62.08	15.94
Pan		285.03	296.78	11.75	15.94	

Sieve Number	Diameter (mm)	Mass of Sieve (gm)	Mass of Sieve & Soil (gm)	Soil Retained (gm)	Soil Retained (%)	Soil Passing (%)
#4	4.750	398.59	398.59	0.00	-	100.00
#8	2.360	375.15	375.15	0.00	-	100.00
#16	1.180	367.89	367.89	0.00	-	100.00
#30	0.600	342.91	343.61	0.70	0.83	99.17
#50	0.300	325.43	331.78	6.35	7.52	91.66
#100	0.150	334.98	360.93	25.95	30.71	60.94
#200	0.075	326.81	366.45	39.64	46.92	14.03
Pan		285.03	296.88	11.85	14.03	

USCS Soil Classification: SP-SM - Poorly Graded Sand with Silt

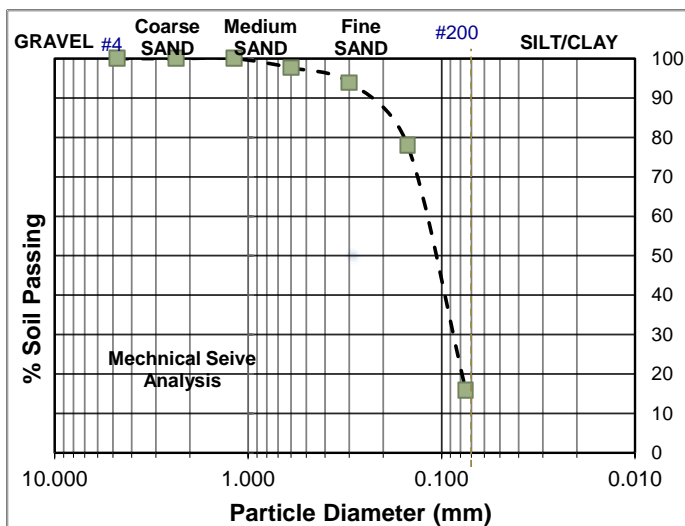

USCS Soil Classification: SP-SM - Poorly Graded Sand with Silt

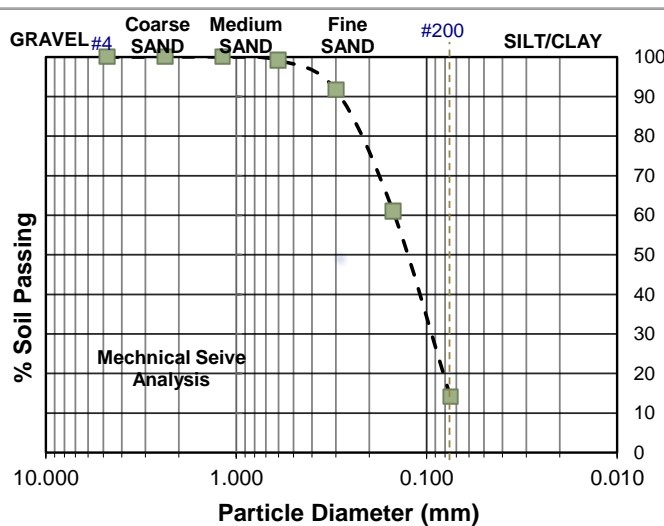

Grain Size Distribution Curve Results :

% Gravel :	0.00	C_u :		D₁₀ :	
% Sand :	84.06	C_c :		D₃₀ :	0.092 mm
% Fines :	15.94			D₆₀ :	0.128 mm
Silt Factor , f :	0.60			D₅₀ :	0.116 mm

% Gravel :	0.0	C_u :		D₁₀ :	
% Sand :	86.0	C_c :		D₃₀ :	0.101 mm
% Fines :	14.0			D₆₀ :	0.148 mm
Silt Factor , f :	0.64			D₅₀ :	0.133 mm

Test Performed by: **Abdul Awal**
 Lab Technician

Countersigned by: **Engr. Md. Sajib Hossain**
 B.Sc. in Civil Engg.(SUB)
 M.Sc.Structural Engg.(YU,China)

Figure- GSD 02

Grain Size Analysis Report (Mechanical Sieve)

As Per ASTM D422-63 (2007)

Client : McGrath Developments Ltd
Project : Proposed Construction of (G+9)-Storied Residential Building
Location : 248/9, Nabinbagh, Khilgaon, Dhaka-1219.
Boring No.: BH- 03
Sample ID: D- 17



Boring No.: BH- 04
Sample ID: D- 20

Sieve Number	Diameter (mm)	Mass of Sieve (gm)	Mass of Sieve & Soil (gm)	Soil Retained (gm)	Soil Retained (%)	Soil Passing (%)
#4	4.750	398.59	398.59	0.00	-	100.00
#8	2.360	375.15	375.15	0.00	-	100.00
#16	1.180	367.89	367.89	0.00	-	100.00
#30	0.600	342.91	343.86	0.95	1.40	98.60
#50	0.300	325.43	327.51	2.08	3.07	95.53
#100	0.150	334.98	342.45	7.47	11.01	84.52
#200	0.075	326.81	369.15	42.34	62.42	22.10
Pan		285.03	300.02	14.99	22.10	

Sieve Number	Diameter (mm)	Mass of Sieve (gm)	Mass of Sieve & Soil (gm)	Soil Retained (gm)	Soil Retained (%)	Soil Passing (%)
#4	4.750	398.59	398.59	0.00	-	100.00
#8	2.360	375.15	375.15	0.00	-	100.00
#16	1.180	367.89	367.89	0.00	-	100.00
#30	0.600	342.91	343.24	0.33	0.47	99.53
#50	0.300	325.43	326.57	1.14	1.63	97.89
#100	0.150	334.98	347.33	12.35	17.69	80.21
#200	0.075	326.81	365.72	38.91	55.73	24.48
Pan		285.03	302.12	17.09	24.48	

USCS Soil Classification: SP-SM - Poorly Graded Sand with Silt

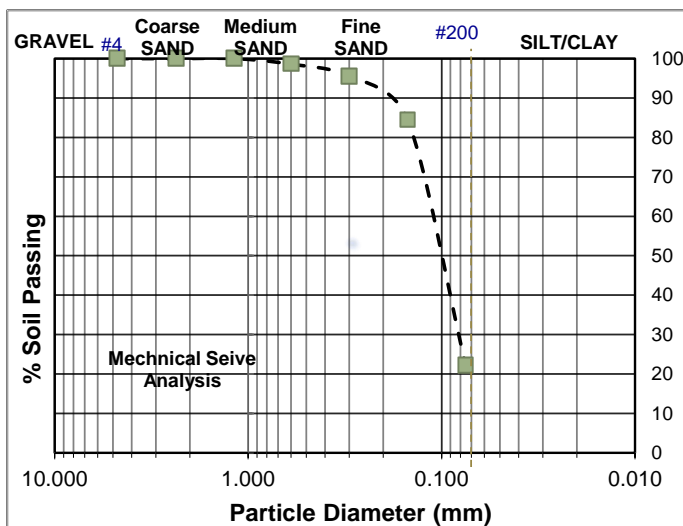

USCS Soil Classification: SP-SM - Poorly Graded Sand with Silt

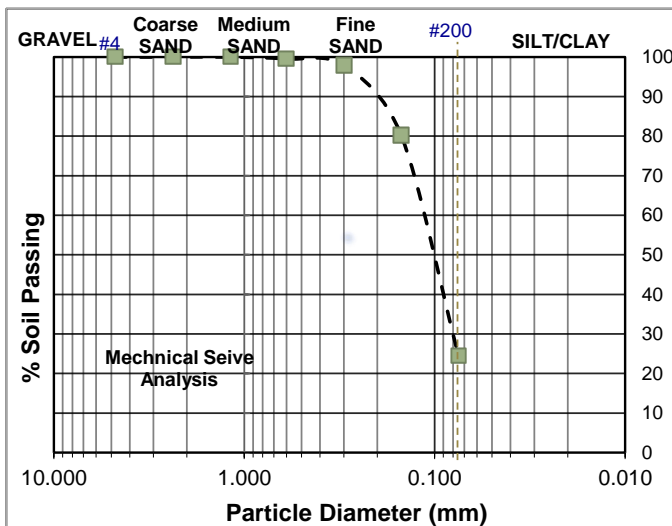

Grain Size Distribution Curve Results :

% Gravel :	0.00	C_u :		D₁₀ :	
% Sand :	77.90	C_c :		D₃₀ :	0.084 mm
% Fines :	22.10			D₆₀ :	0.121 mm
Silt Factor , f :	0.58			D₅₀ :	0.109 mm

% Gravel :	0.0	C_u :		D₁₀ :	
% Sand :	75.5	C_c :		D₃₀ :	0.082 mm
% Fines :	24.5			D₆₀ :	0.123 mm
Silt Factor , f :	0.58			D₅₀ :	0.109 mm

Test Performed by: **Abdul Awal**
Lab Technician

Countersigned by: **Engr. Md. Sajib Hossain**
B.Sc. in Civil Engg.(SUB)
M.Sc.Structural Engg.(YU,China)

Figure- GSD 03

Grain Size Analysis Report (Mechanical Sieve)

As Per ASTM D422-63 (2007)

Client : McGrath Developments Ltd
Project : Proposed Construction of (G+9)-Storied Residential Building
Location : 248/9, Nabinbagh, Khilgaon, Dhaka-1219.
Boring No.: BH- 05
Sample ID: D- 16



Boring No.: BH- 05
Sample ID: D- 19

Sieve Number	Diameter (mm)	Mass of Sieve (gm)	Mass of Sieve & Soil (gm)	Soil Retained (gm)	Soil Retained (%)	Soil Passing (%)
#4	4.750	398.59	398.59	0.00	-	100.00
#8	2.360	375.15	375.15	0.00	-	100.00
#16	1.180	367.89	367.89	0.00	-	100.00
#30	0.600	342.91	344.41	1.50	1.99	98.01
#50	0.300	325.43	328.45	3.02	4.01	93.99
#100	0.150	334.98	346.64	11.66	15.49	78.50
#200	0.075	326.81	372.81	46.00	61.11	17.39
Pan		285.03	298.12	13.09	17.39	

Sieve Number	Diameter (mm)	Mass of Sieve (gm)	Mass of Sieve & Soil (gm)	Soil Retained (gm)	Soil Retained (%)	Soil Passing (%)
#4	4.750	398.59	398.59	0.00	-	100.00
#8	2.360	375.15	375.15	0.00	-	100.00
#16	1.180	367.89	367.89	0.00	-	100.00
#30	0.600	342.91	343.63	0.72	0.93	99.07
#50	0.300	325.43	331.81	6.38	8.23	90.84
#100	0.150	334.98	355.64	20.66	26.66	64.17
#200	0.075	326.81	364.57	37.76	48.74	15.44
Pan		285.03	296.99	11.96	15.44	

USCS Soil Classification: SP-SM - Poorly Graded Sand with Silt

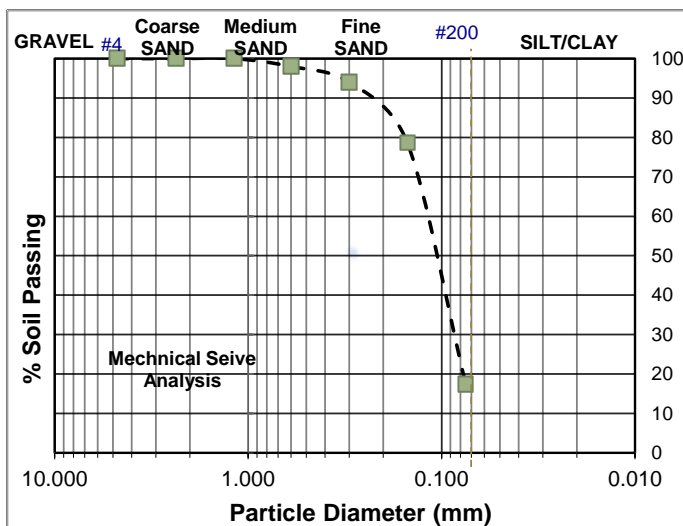

USCS Soil Classification: SP-SM - Poorly Graded Sand with Silt

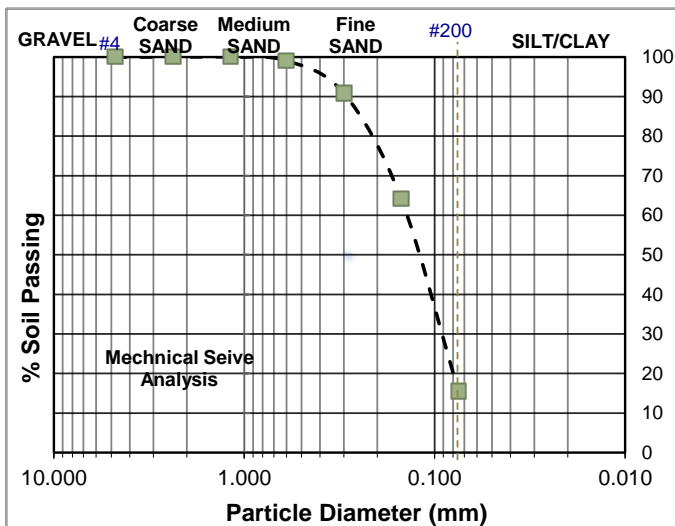

Grain Size Distribution Curve Results :

% Gravel :	0.00	C_u :		D₁₀ :	
% Sand :	82.61	C_c :		D₃₀ :	0.090 mm
% Fines :	17.39			D₆₀ :	0.127 mm
Silt Factor , f :	0.60			D₅₀ :	0.115 mm

% Gravel :	0.0	C_u :		D₁₀ :	
% Sand :	84.6	C_c :		D₃₀ :	0.097 mm
% Fines :	15.4			D₆₀ :	0.144 mm
Silt Factor , f :	0.63			D₅₀ :	0.128 mm

Test Performed by: **Abdul Awal**
 Lab Technician

Countersigned by: **Engr. Md. Sajib Hossain**
 B.Sc. in Civil Engg.(SUB)
 M.Sc.Structural Engg.(YU,China)

Figure- GSD 05

Grain Size Analysis Report (Mechanical Sieve)

As Per ASTM D422-63 (2007)

Client : McGrath Developments Ltd
Project : Proposed Construction of (G+9)-Storied Residential Building
Location : 248/9, Nabinbagh, Khilgaon, Dhaka-1219.
Boring No. : BH- 06
Sample ID: D- 18



Boring No. : BH- 07
Sample ID: D- 19

Sieve Number	Diameter (mm)	Mass of Sieve (gm)	Mass of Sieve & Soil (gm)	Soil Retained (gm)	Soil Retained (%)	Soil Passing (%)
#4	4.750	398.59	398.59	0.00	-	100.00
#8	2.360	375.15	375.15	0.00	-	100.00
#16	1.180	367.89	367.89	0.00	-	100.00
#30	0.600	342.91	343.86	0.95	1.40	98.60
#50	0.300	325.43	327.51	2.08	3.07	95.53
#100	0.150	334.98	342.45	7.47	11.01	84.52
#200	0.075	326.81	369.15	42.34	62.42	22.10
Pan		285.03	300.02	14.99	22.10	

Sieve Number	Diameter (mm)	Mass of Sieve (gm)	Mass of Sieve & Soil (gm)	Soil Retained (gm)	Soil Retained (%)	Soil Passing (%)
#4	4.750	398.59	398.59	0.00	-	100.00
#8	2.360	375.15	375.15	0.00	-	100.00
#16	1.180	367.89	367.89	0.00	-	100.00
#30	0.600	342.91	343.24	0.33	0.47	99.53
#50	0.300	325.43	326.57	1.14	1.63	97.89
#100	0.150	334.98	347.33	12.35	17.69	80.21
#200	0.075	326.81	365.72	38.91	55.73	24.48
Pan		285.03	302.12	17.09	24.48	

USCS Soil Classification: SP-SM - Poorly Graded Sand with Silt

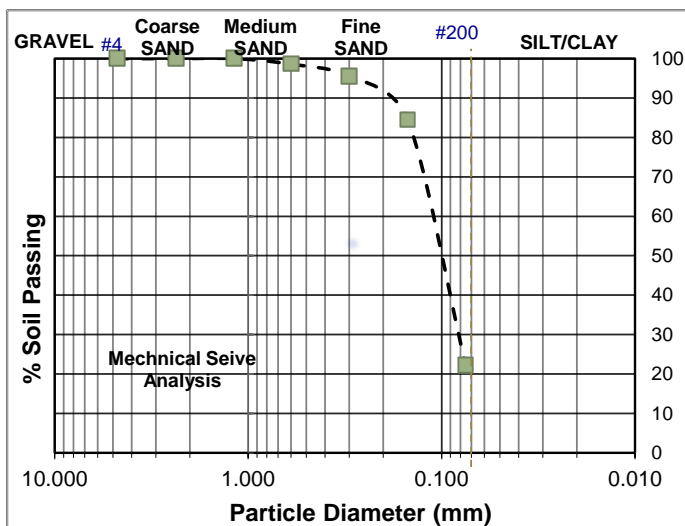

USCS Soil Classification: SP-SM - Poorly Graded Sand with Silt

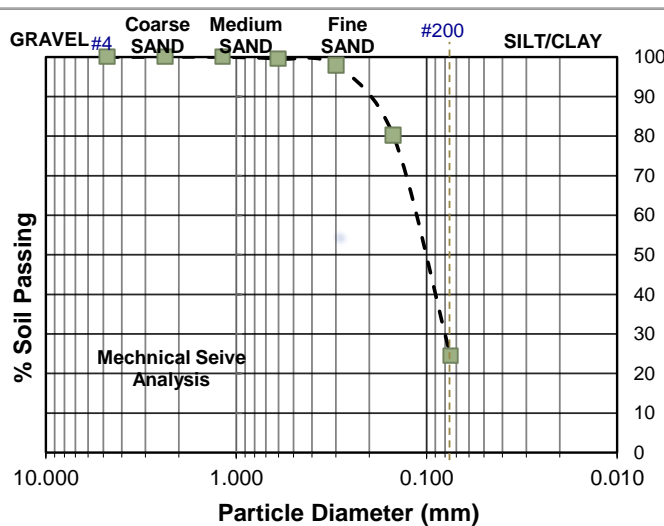

Grain Size Distribution Curve Results :

% Gravel :	0.00	C_u :		D₁₀ :	
% Sand :	77.90	C_c :		D₃₀ :	0.084 mm
% Fines :	22.10			D₆₀ :	0.121 mm
Silt Factor , f :	0.58			D₅₀ :	0.109 mm

% Gravel :	0.0	C_u :		D₁₀ :	
% Sand :	75.5	C_c :		D₃₀ :	0.082 mm
% Fines :	24.5			D₆₀ :	0.123 mm
Silt Factor , f :	0.58			D₅₀ :	0.109 mm

Test Performed by: **Abdul Awal**
Lab Technician

Countersigned by: **Engr. Md. Sajib Hossain**
B.Sc. in Civil Engg.(SUB)
M.Sc.Structural Engg.(YU,China)

Figure- GSD 06

Client : McGrath Developments Ltd
 Project Name: Proposed Construction of (G+9)-Storied Residential Building
 Location : 248/9, Nabinbagh, Khilgaon, Dhaka-1219.
 Boring No : BH- 01
 Sample Depth: (-) 4.50 m



Determination of Liquid Limits

Item	Symbol	Units	1	2	3	4	5
No. of Blows	N		19	22	26	31	34
Mass of can	M _c	gm	28	28	28	28	28
Mass of dry soil + can	M _c +M _s	gm	34.73	34.68	35.28	35.22	35.23
Mass of dry soil	M _s	gm	6.73	6.68	7.28	7.22	7.23
Mass of wet soil + can	M _c +M _{s-sat}	gm	38.16	37.9	37.92	37.55	37.49
Mass of Water	M _w	gm	3.43	3.22	2.64	2.33	2.26
Water Content	w	%	50.97	48.20	36.26	32.27	31.26
Liquid Limit	LL	%	41.8				

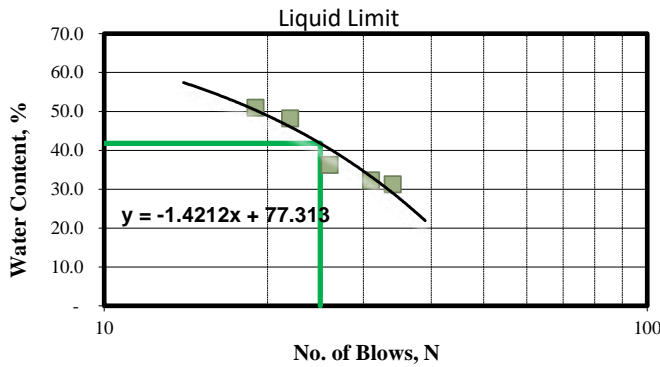

Laboratory Result :

Sample ID =	D - 3
Liquid Limit, LL =	41.8
Plastic Limit, PL =	37.8
Plasticity Index I _p =	4.0
Natural Water Content =	39.79
Liquidity Index, LI =	0.50

Determination of Plastic Limit

Item	Symbol	Units	1	2	3	4	5
Mass of can	M _c	gm	28	28	28	28	28
Mass of dry soil + can	M _c +M _s	gm	34.58	34.57	34.6	34.52	34.62
Mass of dry soil	M _s	gm	6.58	6.57	6.6	6.52	6.62
Mass of wet soil + can	M _c +M _{s-sat}	gm	37.29	37.17	37.1	36.91	36.84
Mass of Water	M _w	gm	2.71	2.6	2.5	2.39	2.22
Water Content	w	%	41.19	39.57	37.88	36.66	33.53
Plastic Limit	PL	%	37.8				

Test Performed by: **Abdul Awal**
 Lab Technician

Countersigned by: **Engr. Md. Sajib Hossain**
 B.Sc. in Civil Engg.(SUB)
 M.Sc.Structural Engg.(YU,China)

Client : McGrath Developments Ltd
 Project Name: Proposed Construction of (G+9)-Storied Residential Building
 Location : 248/9, Nabinbagh, Khilgaon, Dhaka-1219.
 Boring No : BH- 02
 Sample Depth: (-) 6.00 m



Determination of Liquid Limits

Item	Symbol	Units	1	2	3	4	5
No. of Blows	N		19	22	26	31	34
Mass of can	M _c	gm	28	28	28	28	28
Mass of dry soil + can	M _c +M _s	gm	34.85	34.76	35.51	35.19	35.26
Mass of dry soil	M _s	gm	6.85	6.76	7.51	7.19	7.26
Mass of wet soil + can	M _c +M _{s-sat}	gm	37.81	37.53	37.98	37.48	37.25
Mass of Water	M _w	gm	2.96	2.77	2.47	2.29	1.99
Water Content	w	%	43.21	40.98	32.89	31.85	27.41
Liquid Limit	LL	%	36.7				

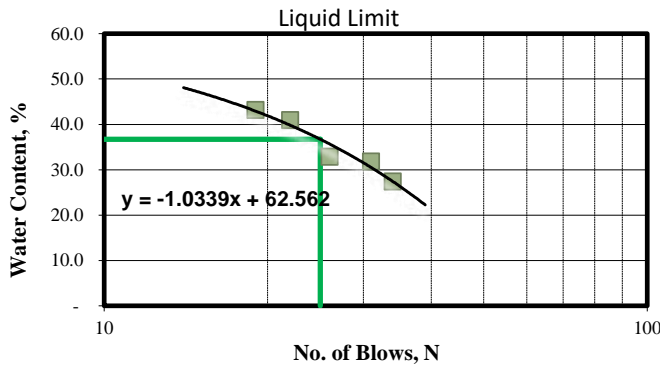

Laboratory Result :

Sample ID =	D - 4
Liquid Limit, LL =	36.7
Plastic Limit, PL =	30.6
Plasticity Index I _p =	6.1
Natural Water Content =	35.27
Liquidity Index, LI =	0.76

Determination of Plastic Limit

Item	Symbol	Units	1	2	3	4	5
Mass of can	M _c	gm	28	28	28	28	28
Mass of dry soil + can	M _c +M _s	gm	31.66	31.61	31.62	31.53	31.52
Mass of dry soil	M _s	gm	3.66	3.61	3.62	3.53	3.52
Mass of wet soil + can	M _c +M _{s-sat}	gm	32.94	32.7	32.71	32.56	32.53
Mass of Water	M _w	gm	1.28	1.09	1.09	1.03	1.01
Water Content	w	%	34.97	30.19	30.11	29.18	28.69
Plastic Limit	PL	%	30.6				

Test Performed by: **Abdul Awal**
 Lab Technician

Countersigned by: **Engr. Md. Sajib Hossain**
 B.Sc. in Civil Engg.(SUB)
 M.Sc.Structural Engg.(YU,China)

Client : McGrath Developments Ltd
 Project Name: Proposed Construction of (G+9)-Storied Residential Building
 Location : 248/9, Nabinbagh, Khilgaon, Dhaka-1219.
 Boring No : BH- 03
 Sample Depth: (-) 7.50 m



Determination of Liquid Limits

Item	Symbol	Units	1	2	3	4	5
No. of Blows	N		19	22	26	31	34
Mass of can	M _c	gm	28	28	28	28	28
Mass of dry soil + can	M _c +M _s	gm	34.85	34.76	35.51	35.19	35.26
Mass of dry soil	M _s	gm	6.85	6.76	7.51	7.19	7.26
Mass of wet soil + can	M _c +M _{s-sat}	gm	37.879	37.56	37.96	37.54	37.43
Mass of Water	M _w	gm	3.029	2.8	2.45	2.35	2.17
Water Content	w	%	44.22	41.42	32.62	32.68	29.89
Liquid Limit	LL	%	37.5				

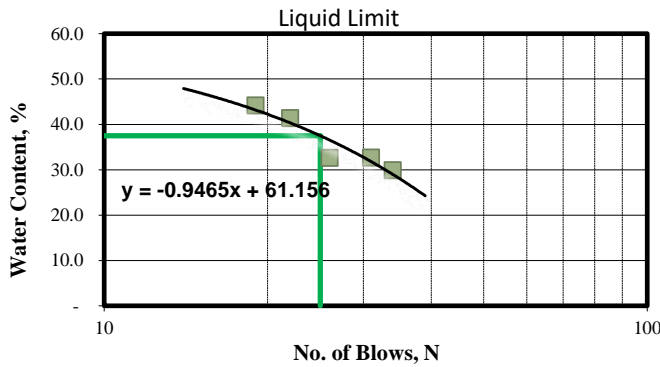

Laboratory Result :

Sample ID =	D - 5
Liquid Limit, LL =	37.5
Plastic Limit, PL =	30.8
Plasticity Index I _p =	6.7
Natural Water Content =	36.17
Liquidity Index, LI =	0.80

Determination of Plastic Limit

Item	Symbol	Units	1	2	3	4	5
Mass of can	M _c	gm	28	28	28	28	28
Mass of dry soil + can	M _c +M _s	gm	31.66	31.61	31.62	31.53	31.52
Mass of dry soil	M _s	gm	3.66	3.61	3.62	3.53	3.52
Mass of wet soil + can	M _c +M _{s-sat}	gm	32.93	32.69	32.74	32.57	32.54
Mass of Water	M _w	gm	1.27	1.08	1.12	1.04	1.02
Water Content	w	%	34.70	29.92	30.94	29.46	28.98
Plastic Limit	PL	%	30.8				

Test Performed by: **Abdul Awal**
 Lab Technician

Countersigned by: **Engr. Md. Sajib Hossain**
 B.Sc. in Civil Engg.(SUB)
 M.Sc.Structural Engg.(YU,China)

Client : McGrath Developments Ltd
 Project Name: Proposed Construction of (G+9)-Storied Residential Building
 Location : 248/9, Nabinbagh, Khilgaon, Dhaka-1219.
 Boring No : BH- 04
 Sample Depth: (-) 4.50 m



Determination of Liquid Limits

Item	Symbol	Units	1	2	3	4	5
No. of Blows	N		19	22	26	31	34
Mass of can	M _c	gm	28	28	28	28	28
Mass of dry soil + can	M _c +M _s	gm	34.86	34.77	35.5	35.18	35.25
Mass of dry soil	M _s	gm	6.86	6.77	7.5	7.18	7.25
Mass of wet soil + can	M _c +M _{s-sat}	gm	37.61	37.22	37.73	37.05	36.71
Mass of Water	M _w	gm	2.75	2.45	2.23	1.87	1.46
Water Content	w	%	40.09	36.19	29.73	26.04	20.14
Liquid Limit	LL	%	32.2				

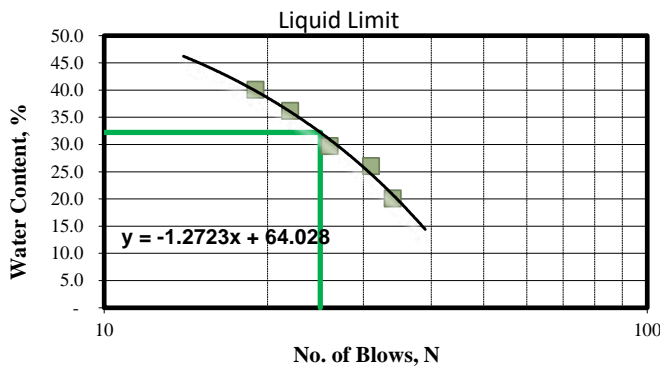

Laboratory Result :

Sample ID =	D - 3
Liquid Limit, LL =	32.2
Plastic Limit, PL =	25.4
Plasticity Index I _p =	6.8
Natural Water Content =	30.44
Liquidity Index, LI =	0.74

Determination of Plastic Limit

Item	Symbol	Units	1	2	3	4	5
Mass of can	M _c	gm	28	28	28	28	28
Mass of dry soil + can	M _c +M _s	gm	31.66	31.61	31.62	31.53	31.52
Mass of dry soil	M _s	gm	3.66	3.61	3.62	3.53	3.52
Mass of wet soil + can	M _c +M _{s-sat}	gm	32.5	32.49	32.57	32.45	32.48
Mass of Water	M _w	gm	0.84	0.88	0.95	0.92	0.96
Water Content	w	%	22.95	24.38	26.24	26.06	27.27
Plastic Limit	PL	%	25.4				

Test Performed by: **Abdul Awal**
 Lab Technician

Countersigned by: **Engr. Md. Sajib Hossain**
 B.Sc. in Civil Engg.(SUB)
 M.Sc.Structural Engg.(YU,China)

Client : McGrath Developments Ltd
 Project Name: Proposed Construction of (G+9)-Storied Residential Building
 Location : 248/9, Nabinbagh, Khilgaon, Dhaka-1219.
 Boring No : BH- 05
 Sample Depth: (-) 7.50 m



Determination of Liquid Limits

Item	Symbol	Units	1	2	3	4	5
No. of Blows	N		19	22	26	31	34
Mass of can	M _c	gm	28	28	28	28	28
Mass of dry soil + can	M _c +M _s	gm	34.87	34.79	35.52	35.15	35.22
Mass of dry soil	M _s	gm	6.87	6.79	7.52	7.15	7.22
Mass of wet soil + can	M _c +M _{s-sat}	gm	37.59	37.21	37.75	37.12	36.75
Mass of Water	M _w	gm	2.72	2.42	2.23	1.97	1.53
Water Content	w	%	39.59	35.64	29.65	27.55	21.19
Liquid Limit	LL	%	32.3				

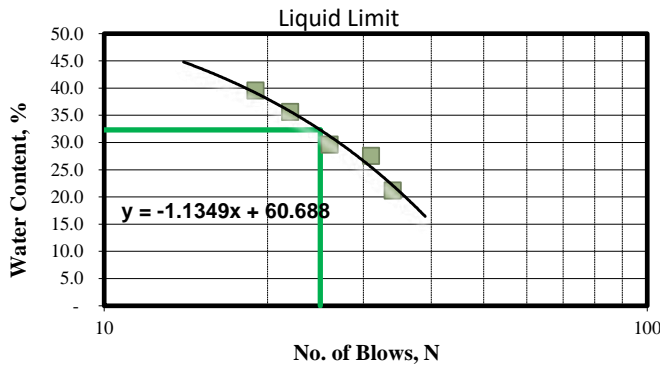

Laboratory Result :

Sample ID =	D - 5
Liquid Limit, LL =	32.3
Plastic Limit, PL =	25.0
Plasticity Index I_p =	7.4
Natural Water Content =	30.73
Liquidity Index, LI =	0.78

Determination of Plastic Limit

Item	Symbol	Units	1	2	3	4	5
Mass of can	M _c	gm	28	28	28	28	28
Mass of dry soil + can	M _c +M _s	gm	31.67	31.61	31.63	31.52	31.53
Mass of dry soil	M _s	gm	3.67	3.61	3.63	3.52	3.53
Mass of wet soil + can	M _c +M _{s-sat}	gm	32.51	32.48	32.57	32.42	32.46
Mass of Water	M _w	gm	0.84	0.87	0.94	0.9	0.93
Water Content	w	%	22.89	24.10	25.90	25.57	26.35
Plastic Limit	PL	%	25.0				

Test Performed by: **Abdul Awal**
 Lab Technician

Countersigned by: **Engr. Md. Sajib Hossain**
 B.Sc. in Civil Engg.(SUB)
 M.Sc.Structural Engg.(YU,China)

Client : McGrath Developments Ltd
 Project Name: Proposed Construction of (G+9)-Storied Residential Building
 Location : 248/9, Nabinbagh, Khilgaon, Dhaka-1219.
 Boring No : BH- 06
 Sample Depth: (-) 6.00 m



Determination of Liquid Limits

Item	Symbol	Units	1	2	3	4	5
No. of Blows	N		19	22	26	31	34
Mass of can	M _c	gm	28	28	28	28	28
Mass of dry soil + can	M _c +M _s	gm	34.86	34.77	35.5	35.18	35.25
Mass of dry soil	M _s	gm	6.86	6.77	7.5	7.18	7.25
Mass of wet soil + can	M _c +M _{s-sat}	gm	37.61	37.22	37.73	37.05	36.71
Mass of Water	M _w	gm	2.75	2.45	2.23	1.87	1.46
Water Content	w	%	40.09	36.19	29.73	26.04	20.14
Liquid Limit	LL	%	32.2				

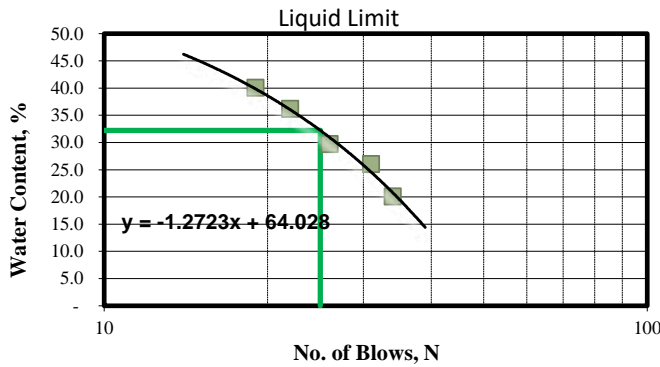

Laboratory Result :

Sample ID =	D - 4
Liquid Limit, LL =	32.2
Plastic Limit, PL =	25.4
Plasticity Index I _p =	6.8
Natural Water Content =	30.44
Liquidity Index, LI =	0.74

Determination of Plastic Limit

Item	Symbol	Units	1	2	3	4	5
Mass of can	M _c	gm	28	28	28	28	28
Mass of dry soil + can	M _c +M _s	gm	31.66	31.61	31.62	31.53	31.52
Mass of dry soil	M _s	gm	3.66	3.61	3.62	3.53	3.52
Mass of wet soil + can	M _c +M _{s-sat}	gm	32.5	32.49	32.57	32.45	32.48
Mass of Water	M _w	gm	0.84	0.88	0.95	0.92	0.96
Water Content	w	%	22.95	24.38	26.24	26.06	27.27
Plastic Limit	PL	%	25.4				

Test Performed by: **Abdul Awal**
 Lab Technician

Countersigned by: **Engr. Md. Sajib Hossain**
 B.Sc. in Civil Engg.(SUB)
 M.Sc.Structural Engg.(YU,China)

Client : McGrath Developments Ltd
 Project Name: Proposed Construction of (G+9)-Storied Residential Building
 Location : 248/9, Nabinbagh, Khilgaon, Dhaka-1219.
 Boring No : BH- 07
 Sample Depth: (-) 6.00 m



Determination of Liquid Limits

Item	Symbol	Units	1	2	3	4	5
No. of Blows	N		19	22	26	31	34
Mass of can	M _c	gm	28	28	28	28	28
Mass of dry soil + can	M _c +M _s	gm	34.85	34.75	35.48	35.16	35.27
Mass of dry soil	M _s	gm	6.85	6.75	7.48	7.16	7.27
Mass of wet soil + can	M _c +M _{s-sat}	gm	37.6	37.21	37.71	37.01	36.66
Mass of Water	M _w	gm	2.75	2.46	2.23	1.85	1.39
Water Content	w	%	40.15	36.44	29.81	25.84	19.12
Liquid Limit	LL	%	32.1				

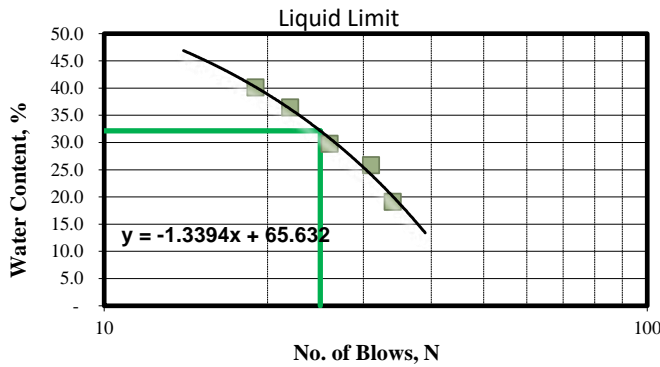

Laboratory Result :

Sample ID =	D - 4
Liquid Limit, LL =	32.1
Plastic Limit, PL =	24.9
Plasticity Index I _p =	7.3
Natural Water Content =	30.27
Liquidity Index, LI =	0.74

Determination of Plastic Limit

Item	Symbol	Units	1	2	3	4	5
Mass of can	M _c	gm	28	28	28	28	28
Mass of dry soil + can	M _c +M _s	gm	31.65	31.6	31.61	31.54	31.5
Mass of dry soil	M _s	gm	3.65	3.6	3.61	3.54	3.5
Mass of wet soil + can	M _c +M _{s-sat}	gm	32.45	32.46	32.47	32.48	32.49
Mass of Water	M _w	gm	0.8	0.86	0.86	0.94	0.99
Water Content	w	%	21.92	23.89	23.82	26.55	28.29
Plastic Limit	PL	%	24.9				

Test Performed by: **Abdul Awal**
 Lab Technician

Countersigned by: **Engr. Md. Sajib Hossain**
 B.Sc. in Civil Engg.(SUB)
 M.Sc.Structural Engg.(YU,China)

CLIENT : McGrath Developments Ltd
 PROJECT : Proposed Construction of (G+9)-Storied Residential Building
 LOCATION : 248/9, Nabinbagh, Khilgaon, Dhaka-1219.



UNCONFINED COMPRESSION STRENGTH TEST

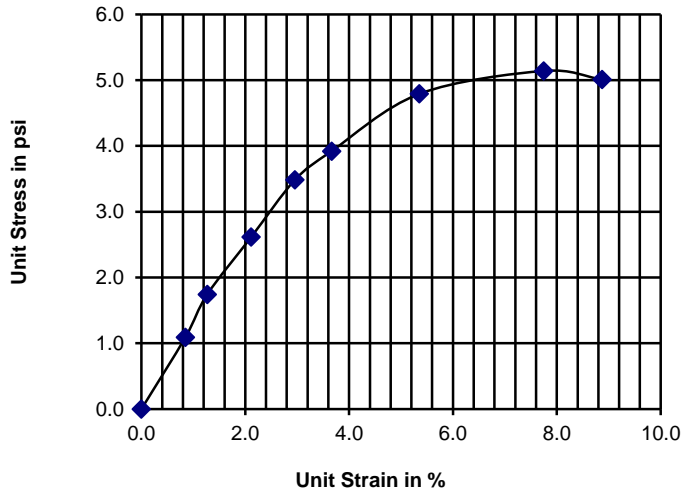

Bore Hole Location BH - 01

Sample ID	UD - 1
Depth (m)	4.05 ~ 4.5

Unconfined Compressive Strength, $q_u = 5.14$ psi
 $c = q_u/2 = 2.57$ psi
 Strain at Max Stress, $\epsilon = 7.746$ %
 Moist Unit weight of Soil, $\gamma_{sat} = 120.3$ pcf
 Dry Unit weight, $\gamma_{dry} = 92.3$ pcf
 Moisture Content, $w = 30.3$ %

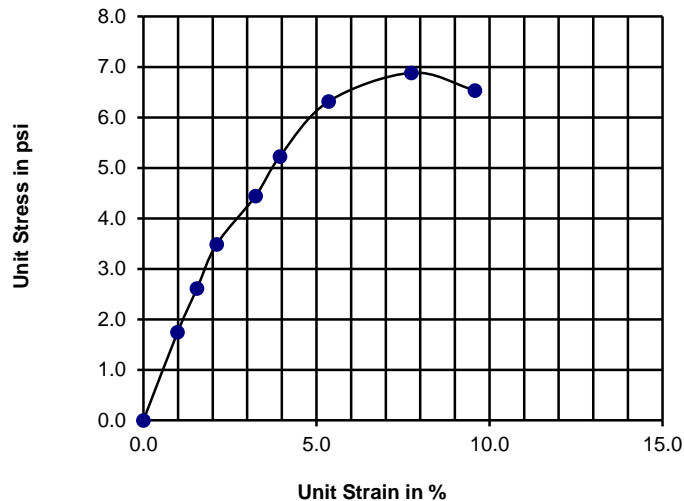

Bore Hole Location BH - 02

Sample ID	UD - 2
Depth (m)	5.55 ~ 6

Unconfined Compressive Strength, $q_u = 6.88$ psi
 $c = q_u/2 = 3.44$ psi
 Strain at Max Stress, $\epsilon = 7.746$ %
 Moist Unit weight of Soil, $\gamma_{sat} = 119.9$ pcf
 Dry Unit weight, $\gamma_{dry} = 91.7$ pcf
 Moisture Content, $w = 30.7$ %

Job Done: **Engr. Md. Sajib Hossain**
 M.Sc. Structural Engg. (YU, China)
 B.Sc. in Civil Engg. (SUB)

DIGITAL SURVEY SOLUTION

Figure- UCT 01

CLIENT : McGrath Developments Ltd
 PROJECT : Proposed Construction of (G+9)-Storied Residential Building
 LOCATION : 248/9, Nabinbagh, Khilgaon, Dhaka-1219.



UNCONFINED COMPRESSION STRENGTH TEST

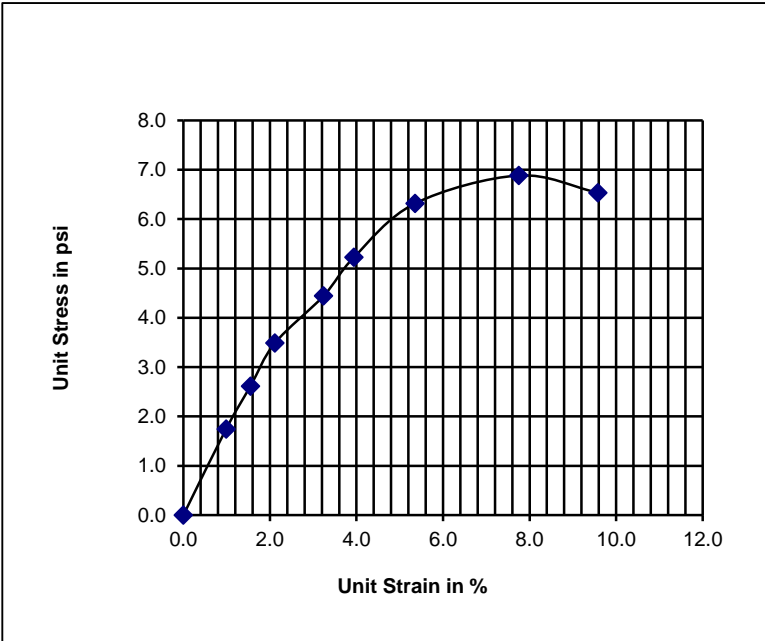

Bore Hole Location BH - 06	
Sample ID	UD - 1
Depth (m)	5.55 ~ 6

Unconfined Compressive Strength, $q_u = 6.88$ psi
 $c = q_u/2 = 3.44$ psi
 Strain at Max Stress, $\epsilon = 7.746$ %
 Moist Unit weight of Soil, $\gamma_{sat} = 119.9$ pcf
 Dry Unit weight, $\gamma_{dry} = 92.3$ pcf
 Moisture Content, $w = 29.9$ %

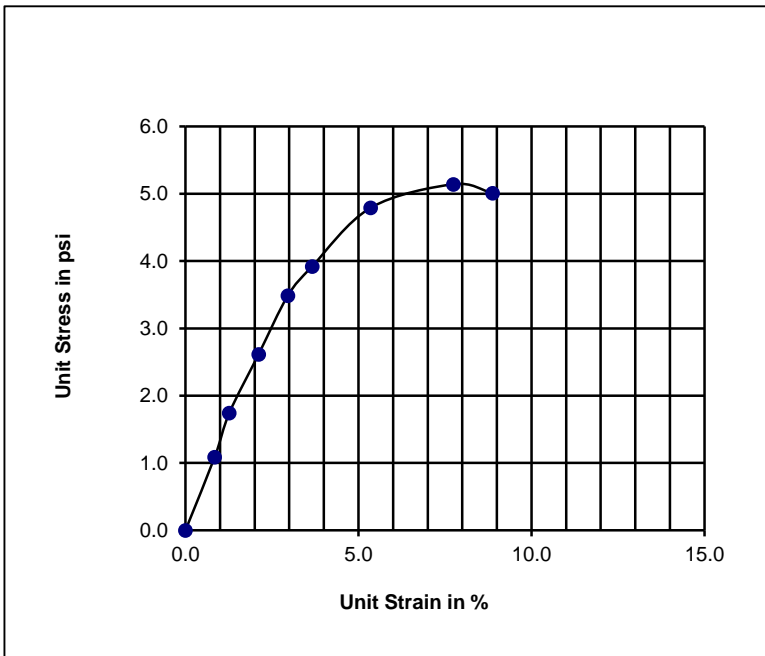

Bore Hole Location BH - 07	
Sample ID	UD - 2
Depth (m)	5.55 ~ 6

Unconfined Compressive Strength, $q_u = 5.14$ psi
 $c = q_u/2 = 2.57$ psi
 Strain at Max Stress, $\epsilon = 7.746$ %
 Moist Unit weight of Soil, $\gamma_{sat} = 120.3$ pcf
 Dry Unit weight, $\gamma_{dry} = 91.7$ pcf
 Moisture Content, $w = 31.2$ %

Job Done: **Engr. Md. Sajib Hossain**
 M.Sc.Structural Engg.(YU,China)
 B.Sc. in Civil Engg.(SUB)

DIGITAL SURVEY SOLUTION

Figure- UCT 06

APPENDIX: C

BEARING CAPACITY CALCULATION

CLIENT : McGrath Developments Ltd
 PROJECT : Proposed Construction of (G+9)-Storied Residential Building
 LOCATION : 248/9, Nabinbagh, Khilgaon, Dhaka-1219.



SHALLOW FOUNDATION LOAD BEARING CAPACITY AT DIFFERENT DEPTH

Table - 1.0

Factor of Safety 3
 Allowable Settlement 1 inch

Average Unit Weight of Soil = 119.7 pcf
 Unit Weight of Water = 62.4 pcf

LOCATION	Depth (ft)	Field SPT - N	Soil Type	p ₀ ' (kN/m ²)	Correction Factor, C _n			N _{corr}	C _u (psf)	Allowable Capacity, q _{all} (ksf)				Bearing Capacity (ksf)	Bearing Capacity (kN/m ²)
					Liao & Whitman	Heydinger	Bazaraa			By Bowles	By Terzaghi	By Mayerhof	By Hansen		
BH- 01	5	2	Rabbish	28.78	1.00	1.00	1.84	2	-	-	0.96	1.04	1.18	-	-
	10	2	Rabbish	42.58	1.00	1.00	1.46	2	-	-	0.92	1.11	1.24	-	-
	15	3	Clay	56.05	1.00	1.00	1.22	3	368.46	1.33	1.39	1.86	2.04	1.33	63.74
	20	4	Clay	69.33	1.00	1.00	1.05	4	491.28	1.80	1.90	2.79	2.90	1.80	85.95
BH- 02	5	1	Rabbish	28.90	1.00	1.00	1.84	1	-	-	0.64	0.71	0.80	-	-
	10	2	Rabbish	42.58	1.00	1.00	1.46	2	-	-	0.96	1.16	1.28	-	-
	15	2	Clay	56.39	1.00	1.00	1.21	2	245.64	0.89	0.96	1.29	1.38	0.89	42.49
	20	4	Clay	69.33	1.00	1.00	1.05	4	491.28	1.80	1.56	2.27	2.55	1.56	74.56
BH- 03	5	3	Rabbish	28.67	1.00	1.00	1.84	3	-	-	1.25	1.33	1.54	-	-
	10	2	Rabbish	42.58	1.00	1.00	1.46	2	-	-	0.96	1.16	1.28	-	-
	15	2	Clay	56.39	1.00	1.00	1.21	2	245.64	0.89	0.96	1.29	1.38	0.89	42.49
	20	3	Clay	69.74	1.00	1.00	1.04	3	368.46	1.35	1.25	1.84	2.01	1.25	60.08
BH- 04	5	1	Rabbish	28.90	1.00	1.00	1.84	1	-	-	0.64	0.71	0.80	-	-
	10	2	Rabbish	42.58	1.00	1.00	1.46	2	-	-	0.96	1.16	1.28	-	-
	15	3	Clay	56.05	1.00	1.00	1.22	3	368.46	1.33	1.25	1.67	1.86	1.25	60.08
	20	4	Clay	69.33	1.00	1.00	1.05	4	491.28	1.80	1.56	2.27	2.55	1.56	74.56
BH- 05	5	1	Clay	28.90	1.00	1.00	1.84	1	122.82	0.42					
	10	1	Clay	42.82	1.00	1.00	1.46	1	122.82	0.44	0.64	0.79	0.84	0.44	21.00
	15	2	Clay	56.39	1.00	1.00	1.21	2	245.64	0.89	0.96	1.29	1.38	0.89	42.49
	20	5	Clay	68.94	1.00	1.00	1.05	5	614.10	2.24	1.91	2.80	3.10	1.91	91.49
BH- 06	5	1	Rabbish	25.91	1.00	1.00	1.95	1	-	-	0.64	0.71	0.80	-	-
	10	1	Rabbish	39.83	1.00	1.00	1.52	1	-	-	0.64	0.79	0.84	-	-
	15	2	Clay	53.39	1.00	1.00	1.26	2	245.64	0.89	0.96	1.29	1.38	0.89	42.49
	20	4	Clay	66.33	1.00	1.00	1.08	4	491.28	1.80	1.56	2.27	2.55	1.56	74.56

CLIENT : McGrath Developments Ltd
 PROJECT : Proposed Construction of (G+9)-Storied Residential Building
 LOCATION : 248/9, Nabinbagh, Khilgaon, Dhaka-1219.



SHALLOW FOUNDATION LOAD BEARING CAPACITY AT DIFFERENT DEPTH

Table - 1.1

Factor of Safety 3
 Allowable Settlement 1 inch

Average Unit Weight of Soil = 120.4 pcf
 Unit Weight of Water = 62.4 pcf

LOCATION	Depth (ft)	Field SPT - N	Soil Type	p ₀ ' (kN/m ²)	Correction Factor, C _n			N _{corr}	C _u (psf)	Allowable Capacity, q _{all} (ksf)				Bearing Capacity (ksf)	Bearing Capacity (kN/m ²)
					Liao & Whitman	Heydinger	Bazaraa			By Bowles	By Terzaghi	By Mayerhof	By Hansen		
BH- 07	5	1	Rabbish	28.90	1.00	1.00	1.84	1	-	-	0.64	0.72	0.80	-	-
	10	1	Rabbish	42.82	1.00	1.00	1.46	1	-	-	0.61	0.75	0.81	-	-
	15	3	Clay	56.05	1.00	1.00	1.22	3	368.46	1.33	1.39	1.86	2.04	1.33	63.74
	20	4	Clay	69.33	1.00	1.00	1.05	4	491.28	1.80	1.90	2.79	2.90	1.80	85.95

CLIENT : McGrath Developments Ltd

PROJECT : Proposed Construction of (G+9)-Storied Residential Building

LOCATION : 248/9, Nabinbagh, Khilgaon, Dhaka-1219.



Chart for Ultimate Skin Friction & End Bearing Capacity of RC Cast-in-situ Pile

TABLE - 2.1

Bore Hole - 01

Depth from EGL	Field SPT Value	Sample Type	γ_s	γ_w	p'_o	C_n	Corrected SPT, N_{corr}	Ultimate Skin Friction	Ultimate End Bearing (E_b)
			pcf	pcf	psf			tsf	tsf
0.0									
5.0	2	R	120.77	62.40	291.86	1.00	2	0.0000	0.00
10.0	2	R	120.77	62.40	583.72	1.00	2	0.0000	0.00
15.0	3	C	120.30	62.40	873.22	1.00	3	0.1773	1.69
20.0	4	C	119.86	62.40	1,160.53	1.00	4	0.2259	2.25
25.0	3	C	120.30	62.40	1,450.03	1.00	3	0.1773	1.69
30.0	3	C	120.30	62.40	1,739.54	1.00	3	0.1773	1.69
35.0	4	C	119.86	62.40	2,026.85	1.00	4	0.2259	2.25
40.0	26	C	118.46	62.40	2,307.13	1.00	26	0.8125	14.63
45.0	28	C	119.11	62.40	2,590.70	1.00	28	0.8750	15.75
50.0	30	C	119.90	62.40	2,878.19	1.00	30	0.9375	16.88
55.0	34	C	121.86	62.40	3,175.50	1.00	34	1.0625	19.13
60.0	37	C	123.68	62.40	3,481.88	1.00	37	1.1563	20.81
65.0	37	C	123.68	62.40	3,788.26	1.00	37	1.1563	20.81
70.0	42	C	127.35	62.40	4,113.02	1.00	42	1.3125	23.63
75.0	40	C	125.78	62.40	4,429.94	1.00	40	1.2500	22.50
80.0	41	S	126.55	62.40	4,750.70	0.63	26	0.2602	34.60
85.0	47	S	131.85	62.40	5,097.93	0.61	29	0.2879	38.29
90.0	48	S	132.84	62.40	5,450.14	0.59	28	0.2844	37.82
95.0	50	S	134.93	62.40	5,812.80	0.57	29	0.2868	38.15
100.0	50	S	134.93	62.40	6,175.46	0.56	28	0.2783	37.01
105.0	50	S	134.93	62.40	6,538.12	0.54	27	0.2705	35.97

Calculation Done :	Sample Note:	"C" -- Clayey Silt/ Silty Clay soil "S" -- Silty Sand/Clayey Sand soil "R" -- Rubbish "W" -- Water "O" -- Organic Soil
Engr. Md. Sajib Hossain M.Sc. Structural Engg. (YU,China) B.Sc. in Civil Engg.(SUB)		

CLIENT : McGrath Developments Ltd

PROJECT : Proposed Construction of (G+9)-Storied Residential Building

LOCATION : 248/9, Nabinbagh, Khilgaon, Dhaka-1219.



Chart for RC Cast-in-situ Pile Capacity at Different Level & Different Diameter

TABLE-3.1

Bore Hole - 01

Depth from EGL	18 inch Dia Bored Pile				20 inch Dia Bored Pile				24 inch Dia Bored Pile			
	Cum Skin Friction	End Bearing	Pile Weight	Allowable Load	Cum Skin Friction	End Bearing	Pile Weight	Allowable Load	Cum Skin Friction	End Bearing	Pile Weight	Allowable Load
ft	Ton	Ton	Ton	Ton	Ton	Ton	Ton	Ton	Ton	Ton	Ton	Ton
	-	-			-	-			-	-		
5.0	-	-	0.66	(0.27)	-	-	0.82	(0.33)	-	-	1.18	(0.47)
10.0	-	-	1.33	(0.53)	-	-	1.64	(0.65)	-	-	2.36	(0.94)
15.0	4.18	2.98	1.99	2.07	4.64	3.68	2.45	2.35	5.57	5.30	3.53	2.94
20.0	9.50	3.98	2.65	4.33	10.56	4.91	3.27	4.88	12.67	7.07	4.71	6.01
25.0	13.68	2.98	3.31	5.34	15.20	3.68	4.09	5.92	18.24	5.30	5.89	7.06
30.0	17.86	2.98	3.98	6.74	19.84	3.68	4.91	7.44	23.81	5.30	7.07	8.82
35.0	23.18	3.98	4.64	9.01	25.75	4.91	5.73	9.97	30.90	7.07	8.25	11.89
40.0	42.32	25.84	5.30	25.15	47.02	31.91	6.54	28.95	56.43	45.95	9.42	37.18
45.0	62.94	27.83	5.96	33.92	69.93	34.36	7.36	38.77	83.92	49.48	10.60	49.12
50.0	85.03	29.82	6.63	43.29	94.48	36.82	8.18	49.24	113.37	53.01	11.78	61.84
55.0	108.59	33.80	7.29	54.04	120.66	41.72	9.00	61.35	144.79	60.08	12.96	76.76
60.0	132.15	36.78	7.95	64.39	146.83	45.41	9.82	72.97	176.20	65.38	14.14	90.98
65.0	155.71	36.78	8.61	73.55	173.01	45.41	10.64	83.11	207.62	65.38	15.32	103.07
70.0	179.28	41.75	9.28	84.70	199.19	51.54	11.45	95.71	239.03	74.22	16.49	118.70
75.0	202.84	39.76	9.94	93.06	225.37	49.09	12.27	104.88	270.45	70.69	17.67	129.39
80.0	208.97	61.15	10.60	103.81	232.19	75.49	13.09	117.84	278.62	108.71	18.85	147.39
85.0	215.75	67.67	11.27	108.86	239.72	83.54	13.91	123.74	287.67	120.30	20.03	155.18
90.0	222.45	66.84	11.93	110.94	247.17	82.51	14.73	125.98	296.60	118.82	21.21	157.69
95.0	229.21	67.41	12.59	113.61	254.68	83.23	15.54	128.94	305.61	119.85	22.38	161.23
100.0	235.77	65.41	13.25	115.17	261.96	80.75	16.36	130.54	314.36	116.28	23.56	162.83
105.0	242.14	63.57	13.92	116.72	269.04	78.48	17.18	132.14	322.85	113.01	24.74	164.45
Calculation Done :												
Remarks :												
Engr. Md. Sajib Hossain M.Sc. Structural Engg. (YU,China) B.Sc. in Civil Engg.(SUB)						Factor of Safety Considered 2.5 Pile Cut-off Level is at the Existing Ground Level Negative Skin Friction is not considered in the calculation						

CLIENT : McGrath Developments Ltd
 PROJECT : Proposed Construction of (G+9)-Storied Residential Building
 LOCATION : 248/9, Nabinbagh, Khilgaon, Dhaka-1219.



TABLE - 2.2

Bore Hole - 02

Depth from EGL	Field SPT Value	Sample Type	γ_s	γ_w	p'_o	C_n	Corrected SPT, N_{corr}	Ultimate Skin Friction	Ultimate End Bearing (E_b)
ft			pcf	pcf	psf			tsf	tsf
0.0									
5.0	1	R	121.28	62.40	294.38	1.00	1	0.0000	0.00
10.0	2	R	120.77	62.40	586.24	1.00	2	0.0000	0.00
15.0	2	C	120.77	62.40	878.10	1.00	2	0.1220	1.13
20.0	4	C	119.86	62.40	1,165.41	1.00	4	0.2259	2.25
25.0	5	C	119.46	62.40	1,450.69	1.00	5	0.2654	2.81
30.0	6	C	119.08	62.40	1,734.09	1.00	6	0.2935	3.38
35.0	5	C	119.46	62.40	2,019.37	1.00	5	0.2654	2.81
40.0	34	C	121.86	62.40	2,316.68	1.00	34	1.0625	19.13
45.0	32	C	120.81	62.40	2,608.75	1.00	32	1.0000	18.00
50.0	37	C	123.68	62.40	2,915.13	1.00	37	1.1563	20.81
55.0	30	C	119.90	62.40	3,202.62	1.00	30	0.9375	16.88
60.0	40	C	125.78	62.40	3,519.55	1.00	40	1.2500	22.50
65.0	42	C	127.35	62.40	3,844.31	1.00	42	1.3125	23.63
70.0	43	C	128.19	62.40	4,173.24	1.00	43	1.3438	24.19
75.0	41	C	126.55	62.40	4,494.00	1.00	41	1.2813	23.06
80.0	42	S	127.35	62.40	4,818.77	0.63	26	0.2646	35.20
85.0	47	S	131.85	62.40	5,166.00	0.61	29	0.2860	38.04
90.0	50	S	134.93	62.40	5,528.66	0.59	29	0.2941	39.12
95.0	50	S	134.93	62.40	5,891.32	0.57	28	0.2849	37.89
100.0	50	S	134.93	62.40	6,253.98	0.55	28	0.2765	36.78
105.0	50	S	134.93	62.40	6,616.64	0.54	27	0.2688	35.76

Calculation Done :	Sample Note:	"C" -- Clayey Silt/ Silty Clay soil
Engr. Md. Sajib Hossain M.Sc. Structural Engg. (YU,China) B.Sc. in Civil Engg.(SUB)		"S" -- Silty Sand/Clayey Sand soil "R" -- Rubbish "W" -- Water "O" -- Organic Soil

CLIENT : McGrath Developments Ltd

PROJECT : Proposed Construction of (G+9)-Storied Residential Building

LOCATION : 248/9, Nabinbagh, Khilgaon, Dhaka-1219.



Chart for RC Cast-in-situ Pile Capacity at Different Level & Different Diameter

TABLE - 3.2

Bore Hole - 02

Depth from EGL	18 inch Dia Bored Pile				20 inch Dia Bored Pile				24 inch Dia Bored Pile			
	Cum Skin Friction	End Bearing	Pile Weight	Allowable Load	Cum Skin Friction	End Bearing	Pile Weight	Allowable Load	Cum Skin Friction	End Bearing	Pile Weight	Allowable Load
ft	Ton	Ton	Ton	Ton	Ton	Ton	Ton	Ton	Ton	Ton	Ton	Ton
	-	-			-	-			-	-		
5.0	-	-	0.66	(0.27)	-	-	0.82	(0.33)	-	-	1.18	(0.47)
10.0	-	-	1.33	(0.53)	-	-	1.64	(0.65)	-	-	2.36	(0.94)
15.0	2.87	1.99	1.99	1.15	3.19	2.45	2.45	1.28	3.83	3.53	3.53	1.53
20.0	8.20	3.98	2.65	3.81	9.11	4.91	3.27	4.30	10.93	7.07	4.71	5.31
25.0	14.45	4.97	3.31	6.44	16.05	6.14	4.09	7.24	19.26	8.84	5.89	8.88
30.0	21.36	5.96	3.98	9.34	23.74	7.36	4.91	10.48	28.49	10.60	7.07	12.81
35.0	27.62	4.97	4.64	11.18	30.69	6.14	5.73	12.44	36.82	8.84	8.25	14.96
40.0	51.18	33.80	5.30	31.87	56.87	41.72	6.54	36.82	68.24	60.08	9.42	47.56
45.0	74.74	31.81	5.96	40.23	83.05	39.27	7.36	45.98	99.65	56.55	10.60	58.24
50.0	98.30	36.78	6.63	51.38	109.23	45.41	8.18	58.58	131.07	65.38	11.78	73.87
55.0	120.39	29.82	7.29	57.17	133.77	36.82	9.00	64.63	160.52	53.01	12.96	80.23
60.0	143.95	39.76	7.95	70.31	159.95	49.09	9.82	79.69	191.94	70.69	14.14	99.40
65.0	167.52	41.75	8.61	80.26	186.13	51.54	10.64	90.81	223.35	74.22	15.32	112.90
70.0	191.08	42.74	9.28	89.82	212.31	52.77	11.45	101.45	254.77	75.99	16.49	125.71
75.0	214.64	40.75	9.94	98.18	238.49	50.31	12.27	110.61	286.19	72.45	17.67	136.39
80.0	220.88	62.20	10.60	108.99	245.42	76.78	13.09	123.64	294.50	110.57	18.85	154.49
85.0	227.61	67.22	11.27	113.43	252.90	82.99	13.91	128.79	303.49	119.50	20.03	161.18
90.0	234.54	69.13	11.93	116.70	260.60	85.34	14.73	132.49	312.73	122.89	21.21	165.76
95.0	241.26	66.96	12.59	118.25	268.06	82.67	15.54	134.08	321.68	119.05	22.38	167.34
100.0	247.77	64.99	13.25	119.81	275.30	80.24	16.36	135.67	330.36	115.54	23.56	168.94
105.0	254.11	63.19	13.92	121.35	282.34	78.01	17.18	137.27	338.81	112.33	24.74	170.56

Calculation Done :

Engr. Md. Sajib Hossain
M.Sc. Structural Engg. (YU,China)
B.Sc. in Civil Engg.(SUB)

Remarks :

Factor of Safety Considered 2.5
Pile Cut-off Level is at the Existing Ground Level
Negative Skin Friction is not considered in the calculation

CLIENT : McGrath Developments Ltd

PROJECT : Proposed Construction of (G+9)-Storied Residential Building

LOCATION : 248/9, Nabinbagh, Khilgaon, Dhaka-1219.

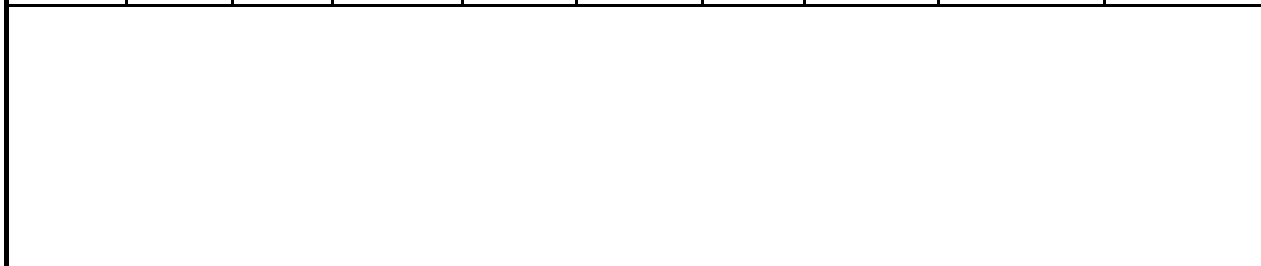

Chart for Ultimate Skin Friction & End Bearing Capacity of RC Cast-in-situ Pile

TABLE - 2.3

Bore Hole - 03

Depth from EGL	Field SPT Value	Sample Type	γ_s	γ_w	p'_o	C_n	Corrected SPT, N_{corr}	Ultimate Skin Friction	Ultimate End Bearing (E_b)
ft			pcf	pcf	psf			tsf	tsf
0.0									
5.0	3	R	120.30	62.40	289.50	1.00	3	0.0000	0.00
10.0	2	R	120.77	62.40	581.36	1.00	2	0.0000	0.00
15.0	2	C	120.77	62.40	873.22	1.00	2	0.1220	1.13
20.0	3	C	120.30	62.40	1,162.73	1.00	3	0.1773	1.69
25.0	4	C	119.86	62.40	1,450.03	1.00	4	0.2259	2.25
30.0	12	C	117.52	62.40	1,725.66	1.00	12	0.3756	6.75
35.0	14	C	117.27	62.40	1,999.99	1.00	14	0.4375	7.88
40.0	13	C	117.38	62.40	2,274.88	1.00	13	0.4063	7.31
45.0	15	C	117.19	62.40	2,548.81	1.00	15	0.4688	8.44
50.0	15	C	117.19	62.40	2,822.74	1.00	15	0.4688	8.44
55.0	20	C	117.27	62.40	3,097.11	1.00	20	0.6250	11.25
60.0	25	C	118.18	62.40	3,376.01	1.00	25	0.7813	14.06
65.0	30	C	119.90	62.40	3,663.50	1.00	30	0.9375	16.88
70.0	37	C	123.68	62.40	3,969.88	1.00	37	1.1563	20.81
75.0	40	C	125.78	62.40	4,286.80	1.00	40	1.2500	22.50
80.0	43	C	128.19	62.40	4,615.73	1.00	43	1.3438	24.19
85.0	46	S	130.88	62.40	4,958.14	0.62	29	0.2857	38.00
90.0	50	S	134.93	62.40	5,320.80	0.60	30	0.2998	39.87
95.0	50	S	134.93	62.40	5,683.46	0.58	29	0.2901	38.58
100.0	50	S	134.93	62.40	6,046.13	0.56	28	0.2812	37.41



Calculation Done :	Sample Note:	"C" -- Clayey Silt/ Silty Clay soil
Engr. Md. Sajib Hossain M.Sc. Structural Engg. (YU,China) B.Sc. in Civil Engg.(SUB)		"S" -- Silty Sand/Clayey Sand soil "R" -- Rubbish "W" -- Water "O" -- Organic Soil

CLIENT : McGrath Developments Ltd

PROJECT : Proposed Construction of (G+9)-Storied Residential Building

LOCATION : 248/9, Nabinbagh, Khilgaon, Dhaka-1219.



Chart for RC Cast-in-situ Pile Capacity at Different Level & Different Diameter

TABLE - 3.3

Bore Hole - 03

Depth from EGL	18 inch Dia Bored Pile				20 inch Dia Bored Pile				24 inch Dia Bored Pile			
	Cum Skin Friction	End Bearing	Pile Weight	Allowable Load	Cum Skin Friction	End Bearing	Pile Weight	Allowable Load	Cum Skin Friction	End Bearing	Pile Weight	Allowable Load
ft	Ton	Ton	Ton	Ton	Ton	Ton	Ton	Ton	Ton	Ton	Ton	Ton
	-	-			-	-			-	-		
5.0	-	-	0.66	(0.27)	-	-	0.82	(0.33)	-	-	1.18	(0.47)
10.0	-	-	1.33	(0.53)	-	-	1.64	(0.65)	-	-	2.36	(0.94)
15.0	2.87	1.99	1.99	1.15	3.19	2.45	2.45	1.28	3.83	3.53	3.53	1.53
20.0	7.05	2.98	2.65	2.95	7.84	3.68	3.27	3.30	9.40	5.30	4.71	4.00
25.0	12.37	3.98	3.31	5.21	13.75	4.91	4.09	5.83	16.50	7.07	5.89	7.07
30.0	21.22	11.93	3.98	11.67	23.58	14.73	4.91	13.36	28.30	21.21	7.07	16.97
35.0	31.53	13.92	4.64	16.32	35.03	17.18	5.73	18.60	42.04	24.74	8.25	23.41
40.0	41.10	12.92	5.30	19.49	45.67	15.95	6.54	22.03	54.80	22.97	9.42	27.34
45.0	52.15	14.91	5.96	24.44	57.94	18.41	7.36	27.59	69.53	26.51	10.60	34.17
50.0	63.19	14.91	6.63	28.59	70.21	18.41	8.18	32.18	84.26	26.51	11.78	39.59
55.0	77.92	19.88	7.29	36.20	86.58	24.54	9.00	40.85	103.89	35.34	12.96	50.51
60.0	96.33	24.85	7.95	45.29	107.03	30.68	9.82	51.16	128.44	44.18	14.14	63.39
65.0	118.42	29.82	8.61	55.85	131.57	36.82	10.64	63.10	157.89	53.01	15.32	78.23
70.0	141.98	36.78	9.28	67.79	157.75	45.41	11.45	76.68	189.30	65.38	16.49	95.28
75.0	165.54	39.76	9.94	78.14	183.93	49.09	12.27	88.30	220.72	70.69	17.67	109.49
80.0	189.10	42.74	10.60	88.50	210.11	52.77	13.09	99.92	252.14	75.99	18.85	123.71
85.0	195.83	67.15	11.27	100.69	217.59	82.91	13.91	114.64	261.11	119.39	20.03	144.19
90.0	202.90	70.46	11.93	104.57	225.44	86.99	14.73	119.08	270.53	125.27	21.21	149.84
95.0	209.73	68.18	12.59	106.13	233.04	84.17	15.54	120.66	279.64	121.20	22.38	151.39
100.0	216.36	66.10	13.25	107.68	240.40	81.61	16.36	122.26	288.48	117.51	23.56	152.97

Calculation Done :

Engr. Md. Sajib Hossain
M.Sc. Structural Engg. (YU,China)
B.Sc. in Civil Engg.(SUB)

Remarks :

Factor of Safety Considered 2.5
Pile Cut-off Level is at the Existing Ground Level
Negative Skin Friction is not considered in the calculation

CLIENT : McGrath Developments Ltd
 PROJECT : Proposed Construction of (G+9)-Storied Residential Building



LOCATION : 248/9, Nabinbagh, Khilgaon, Dhaka-1219.

Chart for Ultimate Skin Friction & End Bearing Capacity of RC Cast-in-situ Pile

TABLE - 2.4

Bore Hole - 04

Depth from EGL	Field SPT Value	Sample Type	γ_s	γ_w	p'_o	C_n	Corrected SPT, N_{corr}	Ultimate Skin Friction	Ultimate End Bearing (E_b)
ft			pcf	pcf	psf			tsf	tsf
0.0									
5.0	1	R	121.28	62.40	294.38	1.00	1	0.0000	0.00
10.0	2	R	120.77	62.40	586.24	1.00	2	0.0000	0.00
15.0	3	C	120.30	62.40	875.75	1.00	3	0.1773	1.69
20.0	4	C	119.86	62.40	1,163.05	1.00	4	0.2259	2.25
25.0	5	C	119.46	62.40	1,448.33	1.00	5	0.2654	2.81
30.0	8	C	118.43	62.40	1,728.49	1.00	8	0.3069	4.50
35.0	12	C	117.52	62.40	2,004.11	1.00	12	0.3756	6.75
40.0	15	C	117.19	62.40	2,278.04	1.00	15	0.4688	8.44
45.0	17	C	117.12	62.40	2,551.66	1.00	17	0.5313	9.56
50.0	18	C	117.14	62.40	2,825.37	1.00	18	0.5625	10.13
55.0	25	C	118.18	62.40	3,104.26	1.00	25	0.7813	14.06
60.0	28	C	119.11	62.40	3,387.82	1.00	28	0.8750	15.75
65.0	37	C	123.68	62.40	3,694.20	1.00	37	1.1563	20.81
70.0	40	C	125.78	62.40	4,011.12	1.00	40	1.2500	22.50
75.0	36	C	123.04	62.40	4,314.32	1.00	36	1.1250	20.25
80.0	37	C	123.68	62.40	4,620.70	1.00	37	1.1563	20.81
85.0	46	C	130.88	62.40	4,963.11	1.00	46	1.4375	25.88
90.0	50	S	134.93	62.40	5,325.77	0.60	30	0.2997	39.86
95.0	50	S	134.93	62.40	5,688.43	0.58	29	0.2900	38.56
100.0	50	S	134.93	62.40	6,051.09	0.56	28	0.2811	37.39



Calculation Done :	Sample Note:	"C" -- Clayey Silt/ Silty Clay soil "S" -- Silty Sand/Clayey Sand soil "R" -- Rubbish "W" -- Water "O" -- Organic Soil
Engr. Md. Sajib Hossain M.Sc. Structural Engg. (YU,China) B.Sc. in Civil Engg.(SUB)		

CLIENT : McGrath Developments Ltd

PROJECT : Proposed Construction of (G+9)-Storied Residential Building

LOCATION : 248/9, Nabinbagh, Khilgaon, Dhaka-1219.



Chart for RC Cast-in-situ Pile Capacity at Different Level & Different Diameter

TABLE - 3.4

Bore Hole - 04

Depth from EGL	18 inch Dia Bored Pile				20 inch Dia Bored Pile				24 inch Dia Bored Pile			
	Cum Skin Friction	End Bearing	Pile Weight	Allowable Load	Cum Skin Friction	End Bearing	Pile Weight	Allowable Load	Cum Skin Friction	End Bearing	Pile Weight	Allowable Load
	Ton	Ton	Ton	Ton	Ton	Ton	Ton	Ton	Ton	Ton	Ton	Ton
ft	-	-	-	-	-	-	-	-	-	-	-	-
5.0	-	-	0.66	(0.27)	-	-	0.82	(0.33)	-	-	1.18	(0.47)
10.0	-	-	1.33	(0.53)	-	-	1.64	(0.65)	-	-	2.36	(0.94)
15.0	4.18	2.98	1.99	2.07	4.64	3.68	2.45	2.35	5.57	5.30	3.53	2.94
20.0	9.50	3.98	2.65	4.33	10.56	4.91	3.27	4.88	12.67	7.07	4.71	6.01
25.0	15.75	4.97	3.31	6.96	17.50	6.14	4.09	7.82	21.00	8.84	5.89	9.58
30.0	22.98	7.95	3.98	10.78	25.54	9.82	4.91	12.18	30.64	14.14	7.07	15.09
35.0	31.83	11.93	4.64	15.65	35.37	14.73	5.73	17.75	42.44	21.21	8.25	22.16
40.0	42.88	14.91	5.30	20.99	47.64	18.41	6.54	23.80	57.17	26.51	9.42	29.70
45.0	55.39	16.90	5.96	26.53	61.55	20.86	7.36	30.02	73.86	30.04	10.60	37.32
50.0	68.65	17.89	6.63	31.97	76.28	22.09	8.18	36.07	91.53	31.81	11.78	44.62
55.0	87.06	24.85	7.29	41.85	96.73	30.68	9.00	47.36	116.07	44.18	12.96	58.92
60.0	107.67	27.83	7.95	51.02	119.64	34.36	9.82	57.67	143.56	49.48	14.14	71.56
65.0	131.23	36.78	8.61	63.76	145.82	45.41	10.64	72.23	174.98	65.38	15.32	90.02
70.0	154.80	39.76	9.28	74.11	172.00	49.09	11.45	83.85	206.40	70.69	16.49	104.24
75.0	178.36	35.78	9.94	81.68	198.18	44.18	12.27	92.03	237.81	63.62	17.67	113.50
80.0	201.92	36.78	10.60	91.24	224.36	45.41	13.09	102.67	269.23	65.38	18.85	126.30
85.0	225.48	45.72	11.27	103.98	250.54	56.45	13.91	117.23	300.64	81.29	20.03	144.76
90.0	232.54	70.43	11.93	116.42	258.38	86.95	14.73	132.24	310.06	125.21	21.21	165.62
95.0	239.38	68.15	12.59	117.97	265.97	84.13	15.54	133.82	319.17	121.15	22.38	167.17
100.0	246.00	66.07	13.25	119.53	273.33	81.57	16.36	135.42	328.00	117.47	23.56	168.76

Calculation Done :

Engr. Md. Sajib Hossain
M.Sc. Structural Engg. (YU,China)
B.Sc. in Civil Engg.(SUB)

Remarks :

Factor of Safety Considered 2.5
Pile Cut-off Level is at the Existing Ground Level
Negative Skin Friction is not considered in the calculation

CLIENT : McGrath Developments Ltd

PROJECT : Proposed Construction of (G+9)-Storied Residential Building

LOCATION : 248/9, Nabinbagh, Khilgaon, Dhaka-1219.

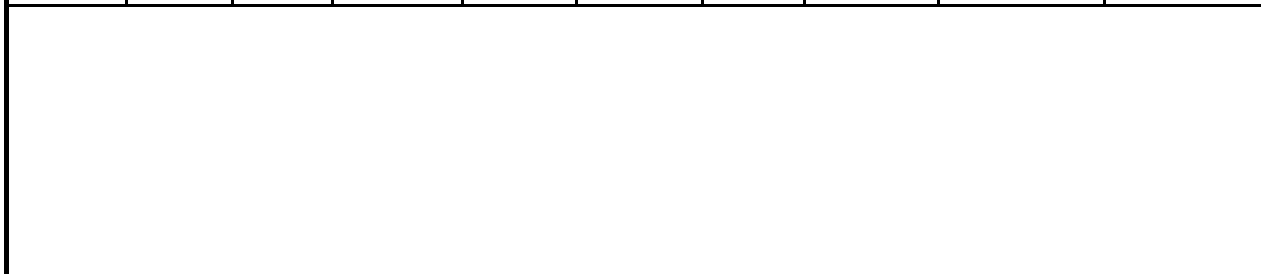

Chart for Ultimate Skin Friction & End Bearing Capacity of RC Cast-in-situ Pile

TABLE - 2.5

Bore Hole - 05

Depth from EGL ft	Field SPT Value	Sample Type	γ_s	γ_w	p'_o	C_n	Corrected SPT, N_{corr}	Ultimate Skin Friction	Ultimate End Bearing (E_b)
			pcf	pcf	psf			tsf	tsf
0.0									
5.0	1	C	121.28	62.40	294.38	1.00	1	0.0621	0.56
10.0	1	C	121.28	62.40	588.76	1.00	1	0.0621	0.56
15.0	2	C	120.77	62.40	880.62	1.00	2	0.1220	1.13
20.0	5	C	119.46	62.40	1,165.90	1.00	5	0.2654	2.81
25.0	7	C	118.74	62.40	1,447.60	1.00	7	0.3081	3.94
30.0	9	C	118.16	62.40	1,726.38	1.00	9	0.3214	5.06
35.0	17	C	117.12	62.40	2,000.00	1.00	17	0.5313	9.56
40.0	18	C	117.14	62.40	2,273.71	1.00	18	0.5625	10.13
45.0	20	C	117.27	62.40	2,548.08	1.00	20	0.6250	11.25
50.0	21	C	117.39	62.40	2,823.03	1.00	21	0.6563	11.81
55.0	30	C	119.90	62.40	3,110.52	1.00	30	0.9375	16.88
60.0	32	C	120.81	62.40	3,402.60	1.00	32	1.0000	18.00
65.0	35	C	122.43	62.40	3,702.77	1.00	35	1.0938	19.69
70.0	31	C	120.34	62.40	3,992.47	1.00	31	0.9688	17.44
75.0	33	C	121.32	62.40	4,287.08	1.00	33	1.0313	18.56
80.0	37	S	123.68	62.40	4,593.46	0.65	24	0.2388	31.76
85.0	44	S	129.05	62.40	4,926.72	0.62	27	0.2742	36.47
90.0	50	S	134.93	62.40	5,289.38	0.60	30	0.3007	39.99
95.0	50	S	134.93	62.40	5,652.04	0.58	29	0.2909	38.69
100.0	50	S	134.93	62.40	6,014.70	0.56	28	0.2820	37.50



Calculation Done :	Sample Note:	"C" -- Clayey Silt/ Silty Clay soil
Engr. Md. Sajib Hossain M.Sc. Structural Engg. (YU,China) B.Sc. in Civil Engg.(SUB)		"S" -- Sandy Silt/ Sandy Clay soil
		"R" -- Rubbish "W" -- Water
		"O" -- Organic Soil

CLIENT : McGrath Developments Ltd

PROJECT : Proposed Construction of (G+9)-Storied Residential Building

LOCATION : 248/9, Nabinbagh, Khilgaon, Dhaka-1219.



Chart for RC Cast-in-situ Pile Capacity at Different Level & Different Diameter

TABLE - 3.5

Bore Hole - 05

Depth from EGL	18 inch Dia Bored Pile				20 inch Dia Bored Pile				24 inch Dia Bored Pile			
	Cum Skin Friction	End Bearing	Pile Weight	Allowable Load	Cum Skin Friction	End Bearing	Pile Weight	Allowable Load	Cum Skin Friction	End Bearing	Pile Weight	Allowable Load
ft	Ton	Ton	Ton	Ton	Ton	Ton	Ton	Ton	Ton	Ton	Ton	Ton
	-	-			-	-			-	-		
5.0	1.46	0.99	0.66	0.72	1.63	1.23	0.82	0.81	1.95	1.77	1.18	1.02
10.0	2.93	0.99	1.33	1.04	3.25	1.23	1.64	1.14	3.90	1.77	2.36	1.33
15.0	5.80	1.99	1.99	2.32	6.45	2.45	2.45	2.58	7.74	3.53	3.53	3.09
20.0	12.05	4.97	2.65	5.75	13.39	6.14	3.27	6.50	16.07	8.84	4.71	8.08
25.0	19.31	6.96	3.31	9.18	21.46	8.59	4.09	10.38	25.75	12.37	5.89	12.89
30.0	26.89	8.95	3.98	12.74	29.88	11.04	4.91	14.40	35.85	15.90	7.07	17.87
35.0	39.40	16.90	4.64	20.67	43.78	20.86	5.73	23.57	52.54	30.04	8.25	29.73
40.0	52.66	17.89	5.30	26.10	58.51	22.09	6.54	29.62	70.21	31.81	9.42	37.04
45.0	67.38	19.88	5.96	32.52	74.87	24.54	7.36	36.82	89.85	35.34	10.60	45.83
50.0	82.85	20.87	6.63	38.84	92.05	25.77	8.18	43.86	110.46	37.11	11.78	54.32
55.0	104.94	29.82	7.29	50.99	116.60	36.82	9.00	57.76	139.92	53.01	12.96	71.99
60.0	128.50	31.81	7.95	60.94	142.78	39.27	9.82	68.89	171.33	56.55	14.14	85.50
65.0	152.06	34.79	8.61	71.29	168.96	42.95	10.64	80.51	202.75	61.85	15.32	99.71
70.0	174.89	30.81	9.28	78.57	194.32	38.04	11.45	88.36	233.18	54.78	16.49	108.59
75.0	198.45	32.80	9.94	88.52	220.50	40.50	12.27	99.49	264.60	58.32	17.67	122.10
80.0	204.07	56.12	10.60	99.84	226.75	69.28	13.09	113.18	272.10	99.77	18.85	141.21
85.0	210.53	64.44	11.27	105.48	233.93	79.55	13.91	119.83	280.71	114.56	20.03	150.10
90.0	217.62	70.67	11.93	110.55	241.80	87.25	14.73	125.73	290.16	125.64	21.21	157.84
95.0	224.47	68.37	12.59	112.10	249.41	84.40	15.54	127.31	299.30	121.54	22.38	159.38
100.0	231.12	66.27	13.25	113.65	256.80	81.82	16.36	128.90	308.16	117.82	23.56	160.97

--

Calculation Done :	Remarks :
<p>Engr. Md. Sajib Hossain M.Sc. Structural Engg. (YU,China) B.Sc. in Civil Engg.(SUB)</p>	<p>Factor of Safety Considered 2.5 Pile Cut-off Level is at the Existing Ground Level Negative Skin Friction is not considered in the calculation</p>

CLIENT : McGrath Developments Ltd

PROJECT : Proposed Construction of (G+9)-Storied Residential Building

LOCATION : 248/9, Nabinbagh, Khilgaon, Dhaka-1219.

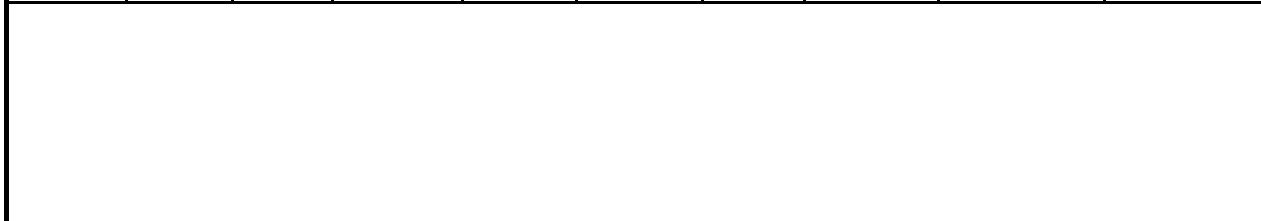

Chart for Ultimate Skin Friction & End Bearing Capacity of RC Cast-in-situ Pile

TABLE - 2.6

Bore Hole - 06

Depth from EGL	Field SPT Value	Sample Type	γ_s	γ_w	p'_o	C_n	Corrected SPT, N_{corr}	Ultimate Skin Friction	Ultimate End Bearing (E_b)
ft			pcf	pcf	psf			tsf	tsf
0.0									
5.0	1	R	121.28	62.40	294.38	1.00	1	0.0000	0.00
10.0	1	R	121.28	62.40	588.76	1.00	1	0.0000	0.00
15.0	2	C	120.77	62.40	880.62	1.00	2	0.1220	1.13
20.0	4	C	119.86	62.40	1,167.93	1.00	4	0.2259	2.25
25.0	5	C	119.46	62.40	1,453.21	1.00	5	0.2654	2.81
30.0	6	C	119.08	62.40	1,736.62	1.00	6	0.2935	3.38
35.0	7	C	118.74	62.40	2,018.32	1.00	7	0.3081	3.94
40.0	10	C	117.91	62.40	2,295.88	1.00	10	0.3402	5.63
45.0	12	C	117.52	62.40	2,571.50	1.00	12	0.3756	6.75
50.0	14	C	117.27	62.40	2,845.83	1.00	14	0.4375	7.88
55.0	17	C	117.12	62.40	3,119.45	1.00	17	0.5313	9.56
60.0	19	C	117.19	62.40	3,393.41	1.00	19	0.5938	10.69
65.0	23	C	117.72	62.40	3,670.01	1.00	23	0.7188	12.94
70.0	42	C	127.35	62.40	3,994.77	1.00	42	1.3125	23.63
75.0	37	C	123.68	62.40	4,301.15	1.00	37	1.1563	20.81
80.0	43	C	128.19	62.40	4,630.08	1.00	43	1.3438	24.19
85.0	44	C	129.05	62.40	4,963.34	1.00	44	1.3750	24.75
90.0	45	S	129.95	62.40	5,301.10	0.60	27	0.2703	35.95
95.0	50	S	134.93	62.40	5,663.76	0.58	29	0.2906	38.65
100.0	50	S	134.93	62.40	6,026.42	0.56	28	0.2817	37.47
105.0	50	S	134.93	62.40	6,389.08	0.55	27	0.2736	36.39



Calculation Done :	Sample Note:	"C" -- Clayey Silt/ Silty Clay soil
Engr. Md. Sajib Hossain M.Sc. Structural Engg. (YU,China) B.Sc. in Civil Engg.(SUB)		"S" -- Sandy Silt/ Sandy Clay soil "R" -- Rubbish "W" -- Water "O" -- Organic Soil

CLIENT : McGrath Developments Ltd

PROJECT : Proposed Construction of (G+9)-Storied Residential Building

LOCATION : 248/9, Nabinbagh, Khilgaon, Dhaka-1219.



Chart for RC Cast-in-situ Pile Capacity at Different Level & Different Diameter

TABLE - 3.6

Bore Hole - 06

Depth from EGL	18 inch Dia Bored Pile				20 inch Dia Bored Pile				24 inch Dia Bored Pile			
	Cum Skin Friction	End Bearing	Pile Weight	Allowable Load	Cum Skin Friction	End Bearing	Pile Weight	Allowable Load	Cum Skin Friction	End Bearing	Pile Weight	Allowable Load
ft	Ton	Ton	Ton	Ton	Ton	Ton	Ton	Ton	Ton	Ton	Ton	Ton
	-	-			-	-			-	-		
5.0	-	-	0.66	(0.27)	-	-	0.82	(0.33)	-	-	1.18	(0.47)
10.0	-	-	1.33	(0.53)	-	-	1.64	(0.65)	-	-	2.36	(0.94)
15.0	2.87	1.99	1.99	1.15	3.19	2.45	2.45	1.28	3.83	3.53	3.53	1.53
20.0	8.20	3.98	2.65	3.81	9.11	4.91	3.27	4.30	10.93	7.07	4.71	5.31
25.0	14.45	4.97	3.31	6.44	16.05	6.14	4.09	7.24	19.26	8.84	5.89	8.88
30.0	21.36	5.96	3.98	9.34	23.74	7.36	4.91	10.48	28.49	10.60	7.07	12.81
35.0	28.63	6.96	4.64	12.38	31.81	8.59	5.73	13.87	38.17	12.37	8.25	16.92
40.0	36.64	9.94	5.30	16.51	40.71	12.27	6.54	18.58	48.85	17.67	9.42	22.84
45.0	45.49	11.93	5.96	20.58	50.54	14.73	7.36	23.16	60.65	21.21	10.60	28.50
50.0	55.80	13.92	6.63	25.23	62.00	17.18	8.18	28.40	74.40	24.74	11.78	34.94
55.0	68.32	16.90	7.29	31.17	75.91	20.86	9.00	35.11	91.09	30.04	12.96	43.27
60.0	82.30	18.89	7.95	37.30	91.45	23.32	9.82	41.98	109.74	33.58	14.14	51.67
65.0	99.24	22.86	8.61	45.40	110.27	28.23	10.64	51.14	132.32	40.64	15.32	63.06
70.0	122.80	41.75	9.28	62.11	136.45	51.54	11.45	70.61	163.74	74.22	16.49	88.59
75.0	146.36	36.78	9.94	69.28	162.63	45.41	12.27	78.30	195.15	65.38	17.67	97.15
80.0	169.93	42.74	10.60	80.83	188.81	52.77	13.09	91.39	226.57	75.99	18.85	113.48
85.0	193.49	43.74	11.27	90.38	214.99	54.00	13.91	102.03	257.98	77.75	20.03	126.28
90.0	199.86	63.53	11.93	100.59	222.06	78.44	14.73	114.31	266.48	112.95	21.21	143.29
95.0	206.70	68.30	12.59	104.96	229.67	84.32	15.54	119.38	275.61	121.42	22.38	149.85
100.0	213.34	66.21	13.25	106.52	237.05	81.74	16.36	120.97	284.46	117.71	23.56	151.44
105.0	219.79	64.30	13.92	108.07	244.21	79.39	17.18	122.57	293.05	114.32	24.74	153.05

--

Calculation Done :	Remarks :
<p>Engr. Md. Sajib Hossain M.Sc. Structural Engg. (YU,China) B.Sc. in Civil Engg.(SUB)</p>	<p>Factor of Safety Considered 2.5 Pile Cut-off Level is at the Existing Ground Level Negative Skin Friction is not considered in the calculation</p>

CLIENT : McGrath Developments Ltd

PROJECT : Proposed Construction of (G+9)-Storied Residential Building

LOCATION : 248/9, Nabinbagh, Khilgaon, Dhaka-1219.



Chart for Ultimate Skin Friction & End Bearing Capacity of RC Cast-in-situ Pile

TABLE - 2.7

Bore Hole - 07

Depth from EGL	Field SPT Value	Sample Type	γ_s	γ_w	p'_o	C_n	Corrected SPT, N_{corr}	Ultimate Skin Friction	Ultimate End Bearing (E_b)
ft			pcf	pcf	psf			tsf	tsf
0.0									
5.0	1	R	121.28	62.40	294.38	1.00	1	0.0000	0.00
10.0	1	R	121.28	62.40	588.76	1.00	1	0.0000	0.00
15.0	3	C	120.30	62.40	878.27	1.00	3	0.1773	1.69
20.0	4	C	119.86	62.40	1,165.57	1.00	4	0.2259	2.25
25.0	6	C	119.08	62.40	1,448.98	1.00	6	0.2935	3.38
30.0	12	C	117.52	62.40	1,724.60	1.00	12	0.3756	6.75
35.0	14	C	117.27	62.40	1,998.93	1.00	14	0.4375	7.88
40.0	17	C	117.12	62.40	2,272.55	1.00	17	0.5313	9.56
45.0	19	C	117.19	62.40	2,546.51	1.00	19	0.5938	10.69
50.0	22	C	117.54	62.40	2,822.20	1.00	22	0.6875	12.38
55.0	24	C	117.93	62.40	3,099.87	1.00	24	0.7500	13.50
60.0	22	C	117.54	62.40	3,375.56	1.00	22	0.6875	12.38
65.0	28	C	119.11	62.40	3,659.12	1.00	28	0.8750	15.75
70.0	30	C	119.90	62.40	3,946.61	1.00	30	0.9375	16.88
75.0	32	C	120.81	62.40	4,238.69	1.00	32	1.0000	18.00
80.0	39	S	125.05	62.40	4,551.93	0.65	25	0.2528	33.63
85.0	44	S	129.05	62.40	4,885.19	0.63	28	0.2753	36.62
90.0	50	S	134.93	62.40	5,247.85	0.60	30	0.3019	40.15
95.0	50	S	134.93	62.40	5,610.52	0.58	29	0.2920	38.83
100.0	50	S	134.93	62.40	5,973.18	0.57	28	0.2830	37.63

--

Calculation Done :	Sample Note:	"C" -- Clayey Silt/ Silty Clay soil
Engr. Md. Sajib Hossain B. Sc. in Civil Engineering (BUET)		"S" -- Sandy Silt/ Sandy Clay soil
		"R" -- Rubbish "W" -- Water
		"O" -- Organic Soil

CLIENT : McGrath Developments Ltd

PROJECT : Proposed Construction of (G+9)-Storied Residential Building

LOCATION : 248/9, Nabinbagh, Khilgaon, Dhaka-1219.



Chart for RC Cast-in-situ Pile Capacity at Different Level & Different Diameter

TABLE - 3.7

Bore Hole - 07

Depth from EGL	18 inch Dia Bored Pile				20 inch Dia Bored Pile				24 inch Dia Bored Pile			
	Cum Skin Friction	End Bearing	Pile Weight	Allowable Load	Cum Skin Friction	End Bearing	Pile Weight	Allowable Load	Cum Skin Friction	End Bearing	Pile Weight	Allowable Load
ft	Ton	Ton	Ton	Ton	Ton	Ton	Ton	Ton	Ton	Ton	Ton	Ton
	-	-			-	-			-	-		
5.0	-	-	0.66	(0.27)	-	-	0.82	(0.33)	-	-	1.18	(0.47)
10.0	-	-	1.33	(0.53)	-	-	1.64	(0.65)	-	-	2.36	(0.94)
15.0	4.18	2.98	1.99	2.07	4.64	3.68	2.45	2.35	5.57	5.30	3.53	2.94
20.0	9.50	3.98	2.65	4.33	10.56	4.91	3.27	4.88	12.67	7.07	4.71	6.01
25.0	16.42	5.96	3.31	7.63	18.24	7.36	4.09	8.61	21.89	10.60	5.89	10.64
30.0	25.27	11.93	3.98	13.29	28.07	14.73	4.91	15.16	33.69	21.21	7.07	19.13
35.0	35.57	13.92	4.64	17.94	39.53	17.18	5.73	20.39	47.43	24.74	8.25	25.57
40.0	48.09	16.90	5.30	23.88	53.43	20.86	6.54	27.10	64.12	30.04	9.42	33.90
45.0	62.08	18.89	5.96	30.00	68.98	23.32	7.36	33.97	82.77	33.58	10.60	42.30
50.0	78.28	21.87	6.63	37.41	86.98	27.00	8.18	42.32	104.37	38.88	11.78	52.59
55.0	95.95	23.86	7.29	45.01	106.61	29.45	9.00	50.83	127.93	42.41	12.96	62.95
60.0	112.15	21.87	7.95	50.43	124.61	27.00	9.82	56.72	149.53	38.88	14.14	69.71
65.0	132.77	27.83	8.61	60.79	147.52	34.36	10.64	68.50	177.02	49.48	15.32	84.47
70.0	154.86	29.82	9.28	70.16	172.06	36.82	11.45	78.97	206.47	53.01	16.49	97.20
75.0	178.42	31.81	9.94	80.11	198.24	39.27	12.27	90.10	237.89	56.55	17.67	110.71
80.0	184.38	59.42	10.60	93.28	204.86	73.36	13.09	106.05	245.83	105.64	18.85	133.05
85.0	190.86	64.71	11.27	97.72	212.07	79.89	13.91	111.22	254.48	115.04	20.03	139.80
90.0	197.98	70.95	11.93	102.80	219.97	87.59	14.73	117.14	263.97	126.13	21.21	147.56
95.0	204.85	68.62	12.59	104.35	227.62	84.72	15.54	118.71	273.14	121.99	22.38	149.10
100.0	211.52	66.50	13.25	105.91	235.02	82.10	16.36	120.31	282.03	118.23	23.56	150.68

Calculation Done :	Remarks :
<p>Engr. Md. Sajib Hossain B. Sc. in Civil Engineering (BUET)</p>	<p>Factor of Safety Considered 2.5 Pile Cut-off Level is at the Existing Ground Level Negative Skin Friction is not considered in the calculation</p>